

**BARCO** DATA  
708

**R9002129**

**OWNER'S MANUAL**



# BARCO

BARCO PROJECTION SYSTEMS

**BARCO** DATA  
708

R9002129

**OWNER'S MANUAL**

Date :  
260597

Art. No. :  
R5975977A

Due to constant research, the information in this manual is subject to change without notice.

Produced by BARCO NV, May 1997.  
All rights reserved.

Trademarks are the rights of their respective owners.

**BARCO nv/Projection Systems**

Noordlaan 5  
B-8520 Kuurne  
Belgium

Printed in Belgium

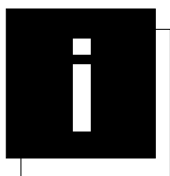

# TABLE OF CONTENTS

TABLE OF CONTENTS .....	1
SAFETY INSTRUCTIONS .....	1-1
On safety .....	1-1
On installation .....	1-2
On servicing .....	1-2
On cleaning .....	1-2
On repacking .....	1-2
On illumination .....	1-2
LOCATION AND FUNCTION OF CONTROLS .....	2-1
Rear Panel Terminology .....	2-1
Front Panel Terminology .....	2-1
Control panel terminology .....	2-2
CONNECTIONS .....	3-1
Switching on/off .....	3-1
Signal input connection to the projector : .....	3-1
Power (mains) cord connection .....	3-1
Connecting a Composite Video source. ....	3-2
Connecting a S-Video or Video source to Port 2. ....	3-3
Connecting a RGB Analog source with composite sync. ....	3-4
Connecting a RGB Analog source with Tri-level sync. ....	3-4
Connecting a Component source. ....	3-5
Connecting a Component source with Tri-level sync. ....	3-5
Connecting a computer, e.g. IBM PC (or compatible), Apple Macintosh to the RS232 input of the projector. ....	3-6
Connecting a RCVDS 05 switcher to the projector. ....	3-6
Connecting a VS05 switcher to the projector. ....	3-6
Connecting an IR Remote Receiver to the projector .....	3-6
Peripheral equipment .....	3-6
CONTROLLING .....	4-1
Battery installation in the RCU. ....	4-1
How to use the RCU .....	4-2
Projector address .....	4-2
How to display a projector address? .....	4-2
How to program an address into the RCU? .....	4-3
Input selection .....	4-3
Picture controls .....	4-4
The Pause key. ....	4-4

START UP OF THE ADJUSTMENT MODE .....	5-1
Adjustment mode .....	5-1
Starting up the random access adjustment mode. ....	6-1
RANDOM ACCESS ADJUSTMENT MODE .....	6-1
Overview 'random Access Adjustment' mode. ....	6-1
Selecting Setup Pattern .....	6-2
Internal Cross Hatch Pattern .....	6-2
Random access adjustment mode selection menu. ....	6-3
Picture Tuning .....	6-3
Color Balance .....	6-3
Sync Fast/Slow Adjustment .....	6-3
Line Doubler (option) .....	6-4
Port 2 : S-Video/Video .....	6-4
Peaking .....	6-4
Color Select.....	6-4
Geometry Adjustments .....	6-5
Horizontal Phase Adjustment .....	6-5
Raster Shift Adjustment .....	6-6
Left-Right (east-west) Adjustments .....	6-7
Top-Bottom (north-south) Adjustments .....	6-8
Size Adjustment .....	6-9
Vertical Linearity Adjustment .....	6-9
Blanking Adjustments .....	6-10
Convergence Adjustment .....	6-11
SERVICE MODE .....	7-1
Starting up the Service mode. ....	7-1
Overview flowchart 'Service' mode. ....	7-1
Projector Set-up .....	7-2
Identification .....	7-2
Total Run Time .....	7-3
Change password .....	7-3
Change Language .....	7-3
Change Projector Address .....	7-4
Change baudrate.....	7-4
Power up mode .....	7-4
BARCO_logo.....	7-5
Memory management.....	7-5
Copy a block .....	7-6
Deletion of blocks .....	7-6
Deleting block by block .....	7-6
Deletion of all blocks .....	7-7
All settings to midposition .....	7-7
Undo all settings to midpos.....	7-7
R & B convergence mid .....	7-8
Undo R & B convergence mid .....	7-8
Green convergence mid .....	7-8
Undo green convergence mid.....	7-8
Common Settings .....	7-9
G2 Adjustment .....	7-9
CRT run in cycle .....	7-9
Projector warm up .....	7-10
CRT Drive Mode .....	7-10
I2C Diagnostics .....	7-11

---

MESSAGES, WARNINGS AND FAILURES ..... 8-1

OPTIONS ..... 9-1

    IR Receiver 800 ..... 9-1

    Hardwired RCU. .... 9-1

    Projector Control software ..... 9-1

    RCVDS 05 Source Selector ..... 9-1

    VS05 Switcher ..... 9-1

    IRIS/2 Auto-Convergence System ..... 9-1

    MAGIK Interface ..... 9-2

    Adapter and communication cables ..... 9-2

    Orbiting Kit ..... 9-2

    Line Doubler Kit ..... 9-2

    Ceiling mount CM50 ..... 9-2

    Soft edge matching kit ..... 9-2

    Contrast modulation kit ..... 9-2

APPENDIX A : ADJUSTMENT BLOCKS AND SOURCE NUMBERS 90 - 99 ..... A-1

    Adjustment Blocks (memory blocks) ..... A-1

    Source numbers 90 - 99 ..... A-1



# 1

## SAFETY INSTRUCTIONS

### Notice on Safety

This equipment is built in accordance with the requirements of the international safety standards EN60950, UL 1950 and CSA C22.2 No.950, which are the safety standards of information technology equipment including electrical business equipment.

These safety standards impose important requirements on the use of safety critical components, materials and isolation, in order to protect the user or operator against risk of electric shock and energy hazard, and having access to live parts.

Safety standards also impose limits to the internal and external temperature rises, radiation levels, mechanical stability and strength, enclosure construction and protection against the risk of fire.

Simulated single fault condition testing ensures the safety of the equipment to the user even when the equipment's normal operation fails.

### INSTALLATION INSTRUCTIONS

***Before operating this equipment please read this manual thoroughly, and retain it for future reference.***

***Installation and preliminary adjustments should be performed by qualified BARCO personnel or by authorized BARCO service dealers.***

### OWNER'S RECORD

The part number and serial number are located at the back side of the projector. Record these numbers in the spaces provided below. Refer to them whenever you call upon your BARCO dealer regarding this product.

**PART NUMBER :**

**SER. NUMBER :**

**DEALER :**

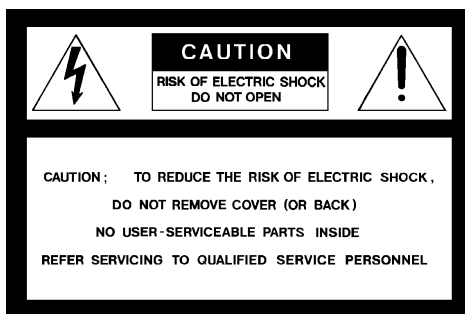

The lightning flash with an arrowhead within a triangle is intended to tell the user that parts inside this product may cause a risk of electrical shock to persons.



The exclamation point within a triangle is intended to tell the user that important operating and/or servicing instructions are included in the technical documentation for this equipment.

**WARNING**  
**TO PREVENT FIRE OR ELECTRICAL SHOCK HAZARD, DO NOT EXPOSE THIS EQUIPMENT TO RAIN OR MOISTURE**

### FEDERAL COMMUNICATION COMMISSION (FCC STATEMENT)

This equipment has been tested and found to comply with the limits of a class A digital device, pursuant to Part 15 of the FCC Rules. These limits are designed to provide reasonable protection against harmful interference when the equipment is operated in a commercial environment. This equipment generates, uses and can radiate radio frequency energy and, if not installed and used in accordance with the instruction manual, may cause harmful interference to radio communications. Operation of this equipment in a residential area is likely to cause harmful interference in which case the user will be required to correct the interference at his own expense.

Note :

The use of shielded cables is required to comply within the limits of Part 15 of FCC rules and EN55022.

\* All the safety and operating instructions should be read before using this unit.

\* The safety and operating instructions manual should be retained for future reference.

\* All warnings on the equipment and in the documentation manuals should be adhered to.

\* All instructions for operating and use of this equipment must be followed precisely.

### On safety

1. This product should be operated from an AC power source. This projector may be connected to an IT-power system.

Operating AC power voltage of the projector:

BARCODATA 708  
Art.No. R9002129 (120V AC)

If you are not sure of the type of AC power available, consult your dealer or local power company.

2. This product is equipped with a 3-wire grounding plug, a plug having a third (grounding) pin. This plug will only fit into a grounding-type power outlet. This is a safety feature. If you are unable to insert the plug into the outlet, contact your electrician to replace your obsolete outlet. Do not defeat the purpose of the grounding-type plug.

**WARNING FOR THE CUSTOMERS: THIS APPARATUS MUST BE GROUNDED (EARTHED) via the supplied 3 conductor AC power cable.**  
(If the supplied power cable is not the correct one, consult your dealer.)

### Power cord with ANSI 73.11 plug:

The wires of the power cord are colored in accordance with the following code.

Green/yellow: ground  
White: neutral  
Black: line (live)

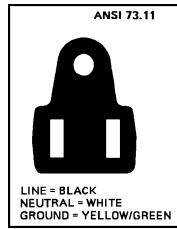

3. Do not allow anything to rest on the power cord. Do not locate this product where persons will walk on the cord.

To disconnect the cord, pull it out by the plug. Never pull the cord itself.

4. If an extension cord is used with this product, make sure that the total of the ampere ratings on the products plugged into the extension cord does not exceed the extension cord ampere rating. Also make sure that the total of all products plugged into the wall outlet does not exceed 15 amperes.

5. Never push objects of any kind into this product through cabinet slots as they may touch dangerous voltage points or short out parts that could result in a risk of fire or electrical shock.

Never spill liquid of any kind on the product. Should any liquid or solid object fall into the cabinet, unplug the set and have it checked by qualified service personnel before resuming operations.

6. Lightning - For added protection for this video product during a lightning storm, or when it is left unattended and unused for long periods of time, unplug it from the wall outlet. This will prevent damage to the projector due to lightning and AC power-line surges.

### On installation

1. Do not place this equipment on an unstable cart, stand, or table. The product may fall, causing serious damage to it.

2. Do not use this equipment near water.

3. Slots and openings in the cabinet and the back or bottom are provided for ventilation; to ensure reliable operation of the product and to protect it from overheating, these openings must not be blocked or covered. The openings should never be blocked by placing the product on a bed, sofa, rug, or other similar surface. This product should never be placed near or over a radiator or heat register.

The projector should not be placed in a built-in installation or enclosure unless proper ventilation is provided.

4. Do not block the projector cooling fans or free air movement under and around the projector. Loose papers or other objects may not be nearer to the projector than 4" on any side.

### On servicing

Do not attempt to service this product yourself, as opening or removing covers may expose you to dangerous voltage potentials and risk of electric shock!

**Refer all servicing to qualified service personnel.**

**Unplug this product from the wall outlet and refer servicing to qualified service personnel under the following conditions:**

- When the power cord or plug is damaged or frayed.
- If liquid has been spilled into the equipment.
- If the product has been exposed to rain or water.
- If the product does not operate normally when the operating

instructions are followed.

Note : Adjust only those controls that are covered by the operating instructions since improper adjustment of the other controls may result in damage and will often require extensive work by a qualified technician to restore the product to normal operation.

e. If the product has been dropped or the cabinet has been damaged.

f. If the product exhibits a distinct change in performance, indicating a need for service.

**Replacement parts** - When replacement parts are required, be sure the service technician has used original BARCO replacement parts or authorized replacement parts which have the same characteristics as the BARCO original part. Unauthorized substitutions may result in degraded performance and reliability, fire, electric shock or other hazards. Unauthorized substitutions may void warranty.

**Safety check** - Upon completion of any service or repairs to this projector, ask the service technician to perform safety checks to determine that the product is in proper operating condition.

### On cleaning

**Unplug this product from the wall outlet before cleaning. Do not use liquid cleaners or aerosol cleaners. Use a damp cloth for cleaning.**

- To keep the cabinet looking brand-new, periodically clean it with a soft cloth. Stubborn stains may be removed with a cloth lightly dampened with mild detergent solution. Never use strong solvents, such as thinner or benzene, or abrasive cleaners, since these will damage the cabinet.
- To ensure the highest optical performance and resolution, the projection lenses are specially treated with an anti-reflective coating, therefore, avoid touching the lens. To remove dust on the lens, use a soft dry cloth. Do not use a damp cloth, detergent solution, or thinner.

### On repacking

Save the original shipping carton and packing material; they will come in handy if you ever have to ship your equipment. For maximum protection, repack your set as it was originally packed at the factory.

### On illumination

In order to obtain the best quality for the projected image, it is essential that the ambient light which is allowed to fall on the screen be kept to an absolute minimum.

When installing the projector and screen, care must be taken to avoid exposure to ambient light directly on the screen. Avoid adverse illumination on the screen from direct sunlight or fluorescent lighting fixtures.

The use of controlled ambient lighting, such as incandescent spot light or a dimmer, is recommended for proper room illumination. Where possible, care should also be taken to ensure that the floors and walls of the room in which the projector is to be installed are non-reflecting, dark surfaces. Brighter surfaces will tend to reflect and diffuse the ambient light and hence reduce the contrast of the projected image on the screen.



### Control panel terminology

#### a. The local keypad

##### Gaining access

The local keypad is covered by a door on which the projector logo is screened.

To open this door, push as indicated on next drawing and turn it to the front side of the projector.

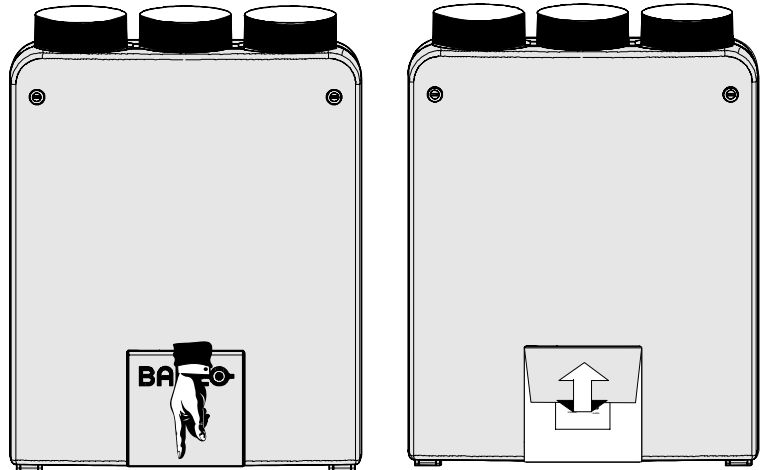

#### b. RCU control panel terminology

This remote control includes a battery powered infrared (IR) transmitter that allows the user to control the projector remotely. This remote control is used for source selection, control, adaptation and set-up. It includes automatic storing of :

- picture controls (Brightness, Sharpness,....)
- picture geometry adjustments
- convergence adjustments

Other functions of the remote control are:

- switching between standby and operational modes
- switching to "pause" (blanked picture, full power for immediate restarting)
- direct access to all connected sources
- variable adjustment speed : when pushing continuously on the arrow keys or the picture keys, the adjustment will be executed in an accelerated fashion.

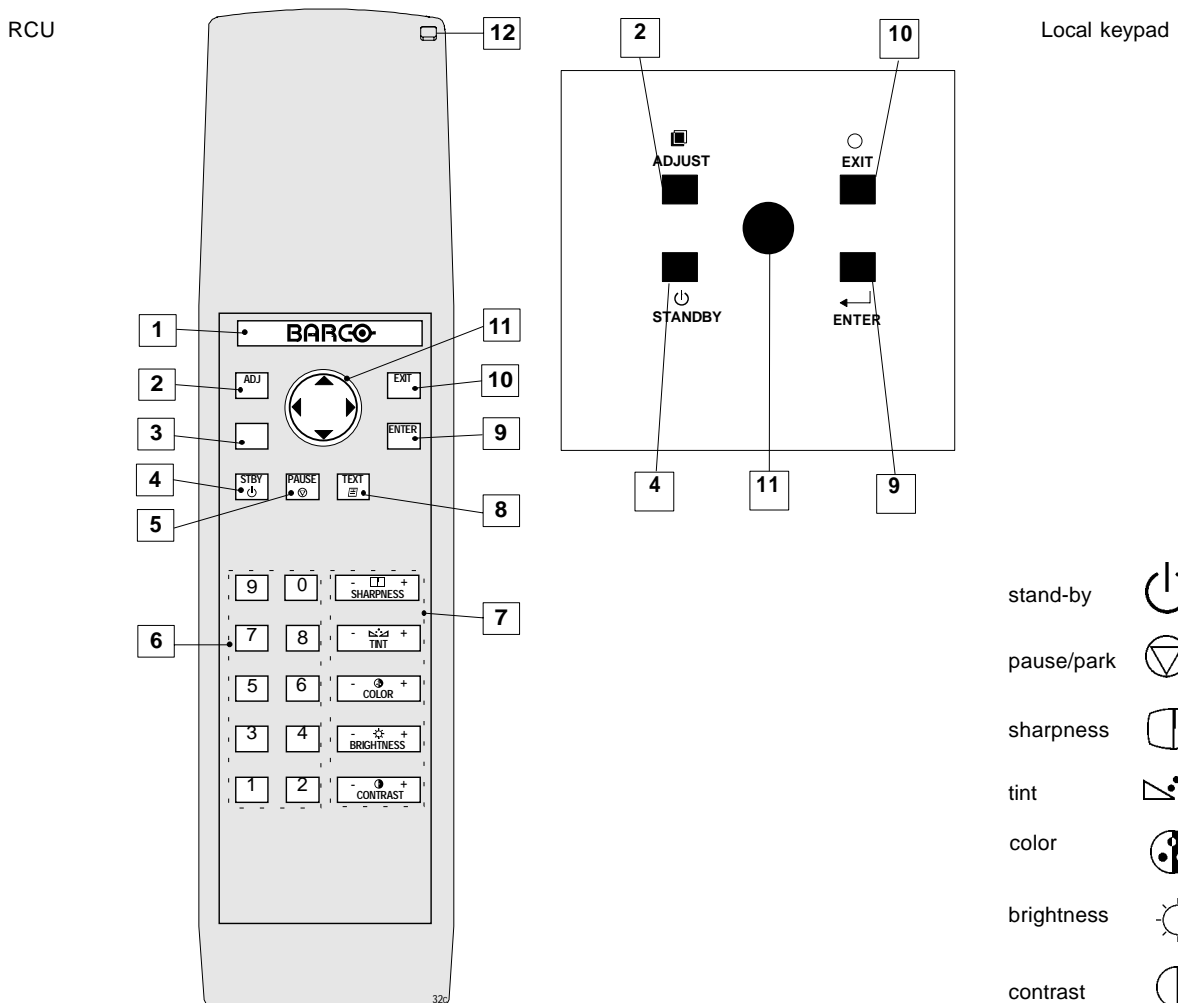

- 
- |   |   |
|---|---|
| <p><b>1</b> <b>Back light key</b> : when activated, all keys will be lit up and visible in the dark.</p> <p><b>2</b> <b>ADJ.</b> : adjust key, to enter or exit the adjustment mode.</p> <p><b>3</b> <b>Address key</b> (recessed key), to enter the address of the projector (between 0 and 9). Press the address key, followed by pressing one digit button between 0 and 9.</p> <p><b>4</b> <b>STBY</b> : stand by button :<br/>- to initiate remote power up operation<br/>- to stop projection without main power off.</p> <p><b>5</b> <b>Pause</b> :to blank the image, press PAUSE. The image disappears but full power is retained for immediate restarting.</p> <p><b>6</b> <b>Digit buttons</b> : direct input selection.</p> <p><b>7</b> <b>Picture controls</b> : use these buttons to obtain the desired level (see also 'Controlling') for each picture function.</p> | <p><b>8</b> <b>TEXT</b> : when adjusting one of the image controls during a meeting, the displayed bar scale can be removed by pressing 'TEXT' key first. To re-display the bar scale on the screen, press 'TEXT' key again. 'TEXT' key is only active in operational mode. When 'TEXT' is off, no warning message will be displayed.</p> <p><b>9</b> <b>ENTER</b> : to start up the adjustment mode or to confirm an adjustment or selection in the adjustment mode.</p> <p><b>10</b> <b>EXIT</b> : to leave the adjustment mode or to scroll upwards when in the adjustment mode.</p> <p><b>11</b> <b>Control disk</b> : to make menu selections when in the adjustment mode. Also allows to increment or decrement an adjustment in the adjustment mode.<br/>control disk up = up arrow in the menus<br/>control disk down = down arrow in the menus<br/>control disk to the right = arrow to the right on the menus<br/>control disk to the left = arrow to the left on the menus</p> <p><b>12</b> <b>RC operating indication</b> : lights up when a button on the remote control is pressed. (This is a visual indicator to check the operation of the remote control)</p> |
|---|---|



# 3

## CONNECTIONS

### Power (mains) cord connection

Use the supplied power cord to connect your projector to the wall outlet. Plug the female power connector into the male connector at the front of the projector.

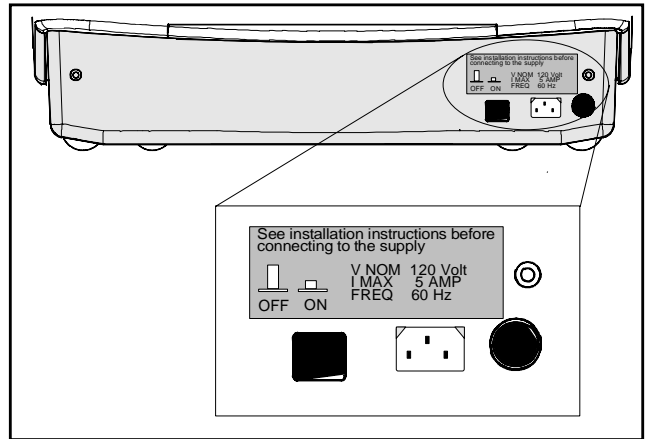

### Switching on/off

The projector is switched ON and OFF using the power (mains) switch ON/OFF.

Pressed : ON  
Not pressed : OFF

The projector can start now in the 'operational mode' (image displayed) or in the 'stand by mode', depending on the position of the 'power up' dip switch on the controller unit. This DIP switch is set during installation by a qualified technician. If you want to change this start up mode, call a qualified technician.

Leds on the front plate of the projector

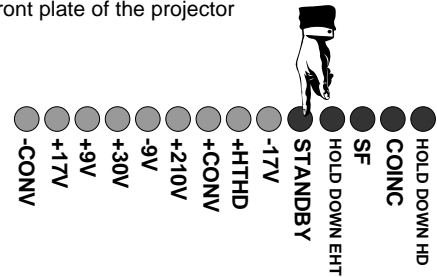

### Signal input connection to the projector :

- Composite Video (\*)
- S-Video (\*)
- RGBS or RGsB
- RGB3S or RG3sB
- (R-Y)Y(B-Y)S or (R-Y)Ys(B-Y) [component input] (\*\*)
- (R-Y)Y(B-Y)3S or (R-Y)Y3s(B-Y) [component input] (\*\*)

(\*) If the line double feature is built in, this feature is available via a software on/off toggle.

(\*\*) If the line double feature is built in, this feature is available for component video signals on standard frequency via software on/off toggle.

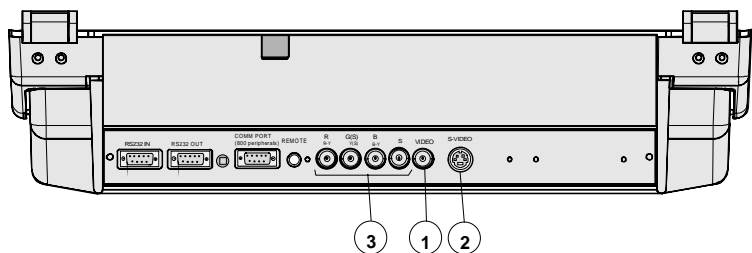

Source No	Projector input	Press digit button
1	Comp. Video	1
2	S-Video*/Comp. Video <sup>1</sup>	2
3	RGBS or RGSB**	3
3	RGB3S or RG3sB***	4
3	(R-Y)Y(B-Y)S or (R-Y)Ys(B-Y)****	5
3	(R-Y)Y(B-Y)3S or (R-Y)Y3s(B-Y)*****	6

\* Input signal Y/C (luma/chroma)  
 \*\* Input signal : R, G and B with composite sync on G or separate composite sync  
 \*\*\* Input signal : R, G and B with Tri level sync on G or separate Tri level sync.  
 \*\*\*\* Input signal : R-Y, Y and B-Y with composite sync on Y or separate composite sync  
 \*\*\*\*\* Input signal : R-Y, Y and B-Y with Tri level sync on Y or separate Tri level sync.  
 1 Video or S-Video : switchable in the Picture Tuning menu.

**Connecting a Composite Video source.**

Composite video signals from a VCR, OFF air signal decoder, etc..

*If a line doubler is built in :  
 the default position of this line doubler is ON (active), the video input signal will be displayed as a non interlaced image (= improved image stability).  
 To enable or to disable this line doubler function, enter the adjustment mode and change the position of the ON/OFF toggle switch (see Picture tuning in chapter 'Guided' adjustment mode or 'Random access' adjustment mode).*

**Video input selection :**

- a. with the RCU : press digit button 1 or
- b. with the local keypad.

(for access to the local keypad, see 'Local keypad' in chapter 'Location and function of controls'.)  
 - press **ADJUST** key, the General access menu is displayed on the screen.

- use the control disk to highlight 1.
- press **ENTER** to select the highlighted source.

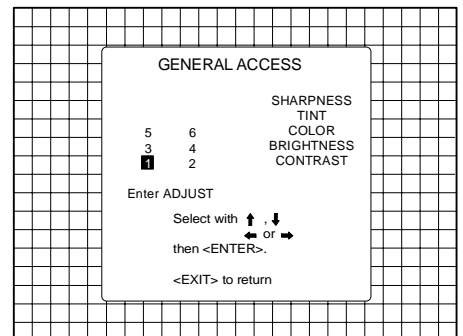
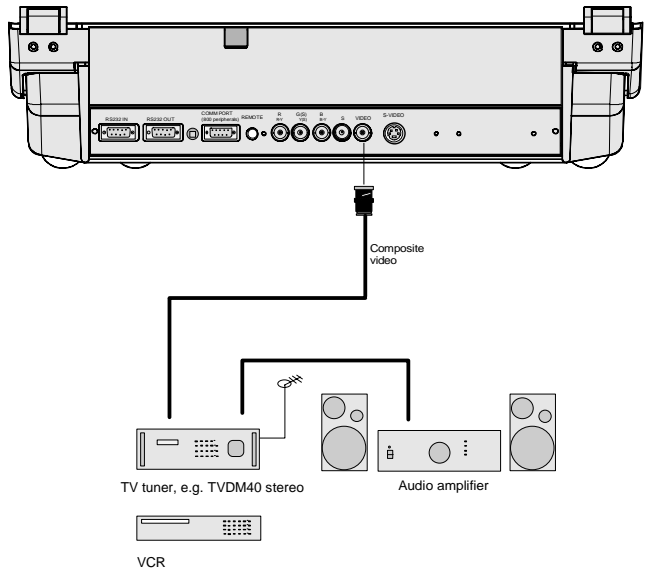



**Connecting a RGB Analog source with composite sync.**

RGB analog input terminals with composite sync input or with sync on green. The projector detects automatically where the sync signal is located.

Always use an interface when a computer and local monitor have to be connected to the projector. Examples of interfaces which can be applied :

Universal analog interface	R9826100
RGB 120 MHz Analog Interface	R9826570 (230V)
Multifunctional Analog Interface Kit (MAGIK)	R9828120 (230V)
	R9828129 (120V)
VGA interface	R9828070 (230V)
	R9828079 (120V)
MAC interface	R9828050 (230V)
	R9828059 (120V)

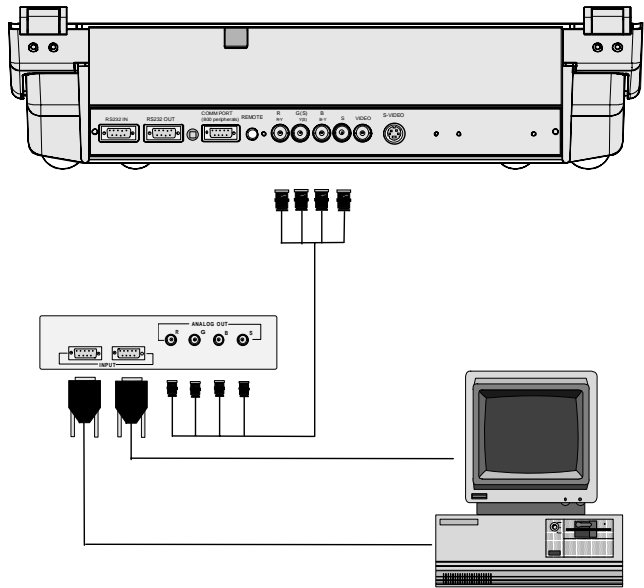

**RGBS or RGSB input selection**

- a. Press digit button 3 on the RCU or
- b. With the local keypad :

(to gain access to the local keypad, see 'Local keypad' in chapter 'Location and function of controls'.)

- Press **ADJUST** key, the General access menu is displayed on the screen.
- Use the control disk to highlight 3.
- Press **ENTER** to select the highlighted source.

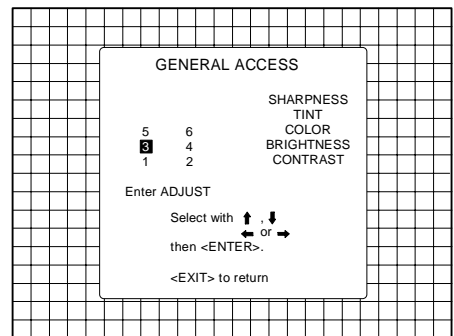

**Connecting a RGB Analog source with Tri-level sync.**

RGB analog input terminals with Tri level sync input or with Tri-level sync on green. The projector detects automatically where the sync signal is located.

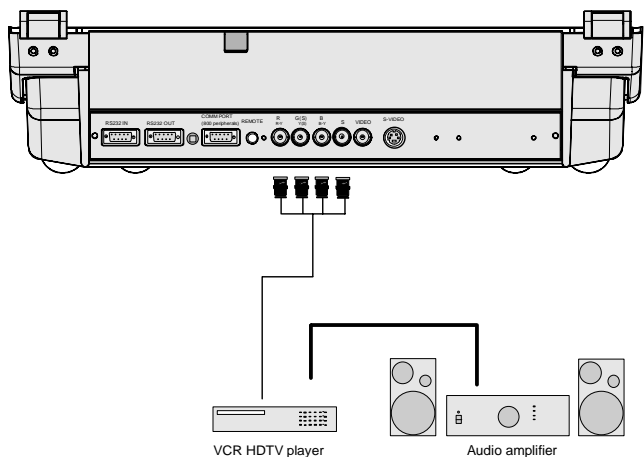

**RGB3S or RG3sB input selection**

- a. Press digit button 4 on the RCU or
- b. With the local keypad :

(to gain access to the local keypad, see 'Local keypad' in chapter 'Location and function of controls'.)

- Press **ADJUST** key, the General access menu is displayed on the screen.
- Use the control disk to highlight 4.
- Press **ENTER** to select the highlighted source.

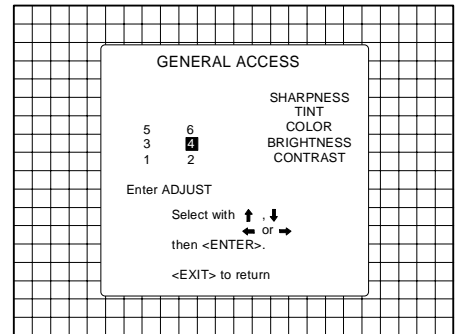

**Connecting a Component source.**

(R-Y)Y(B-Y) analog input terminals with sync input or with sync on the luminance (Y) input. The projector detects automatically where the sync signal is located.

*Line doubling is possible for component video input sources on standard line frequency.*

*If a line doubler is built in : the default position of this line doubler is ON (active), the component video input signal will be displayed as a non interlaced image (= improved image stability).*

*To enable or to disable this line doubler function, enter the adjustment mode and change the position of the ON/OFF toggle switch (see Picture tuning in chapter 'Guided' adjustment mode or 'Random access' adjustment mode).*

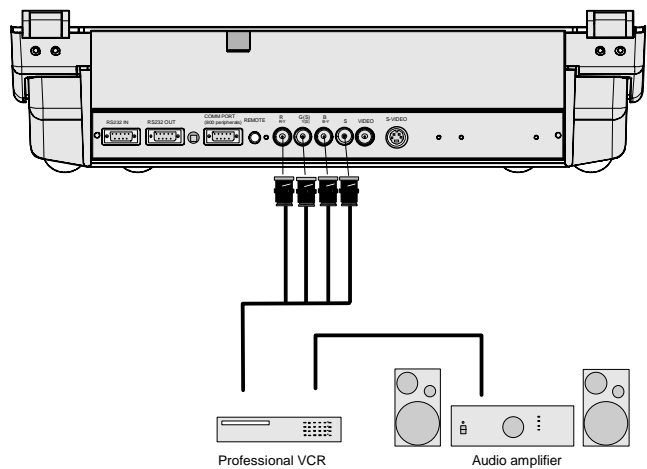

**(R-Y)Y(B-Y)S or (R-Y)Ys(B-Y) input selection**

- a. Press digit button 5 on the RCU or
- b. With the local keypad :
- (to gain access to the local keypad, see 'Local keypad' in chapter 'Location and function of controls'.)
- Press **ADJUST** key, the General access menu is displayed on the screen.
- Use the control disk to highlight 5.
- Press **ENTER** to select the highlighted source.

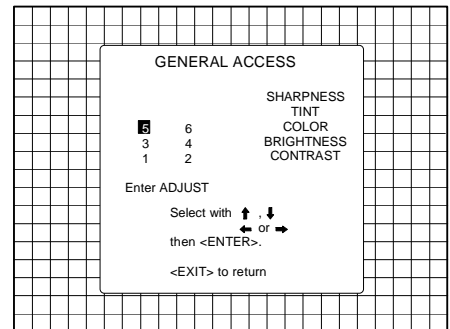

**Connecting a Component source with Tri-level sync.**

(R-Y)Y(B-Y) analog input terminals with Tri-level sync input or with Tri-level sync on the luminance input.

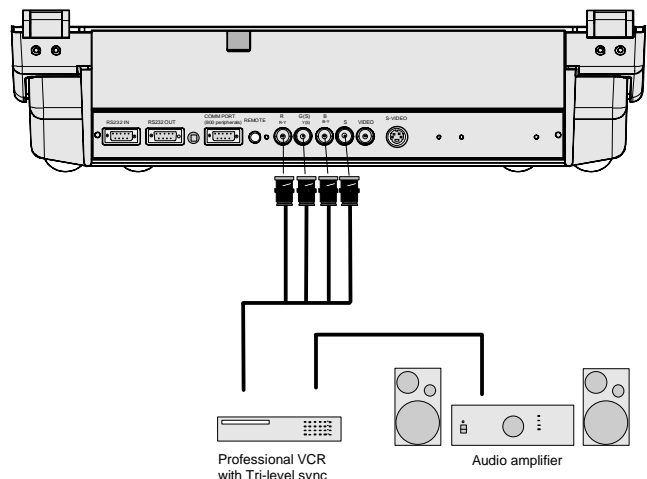

**(R-Y)Y(B-Y)3S or (R-Y)Y3s(B-Y) input selection**

- a. Press digit button 6 on the RCU or
- b. With the local keypad :  
 (to gain access to the local keypad, see 'Local keypad' in chapter 'Location and function of controls'.)  
 - Press **ADJUST** key, the General access menu is displayed on the screen.  
 - Use the control disk to highlight 6.  
 - Press **ENTER** to select the highlighted source.

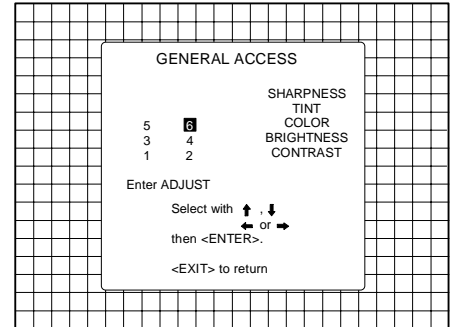

**Connecting a computer, e.g. IBM PC (or compatible), Apple Macintosh to the RS232 input of the projector.**

The projector has a RS232 port that allows it to communicate with a computer.

Applications: remote control and data communications.

**a) remote control:**

- easy adjustment of the projector via IBM PC (or compatible) or MAC connection.
- allow storage of multiple projector configurations and set ups.
- wide range of control possibilities.
- address range from 0 to 255.

**b) data communications:**

- sending data to the projector or copying the data from the projector to a hard memory device.

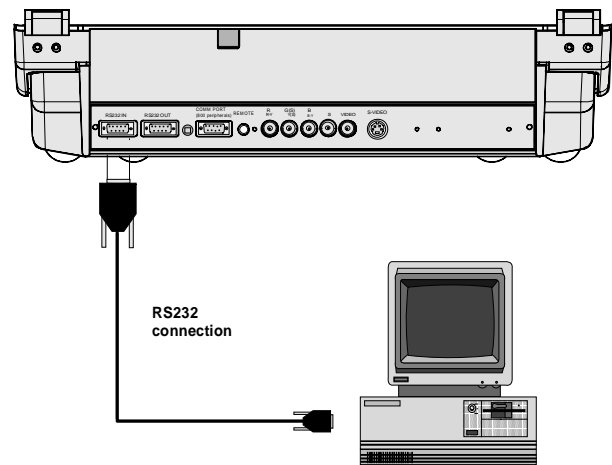

**Peripheral equipment**

**Connecting a RCVDS 05 switcher to the projector.**

- Up to 10 inputs (20 inputs when video and S-video) with the RCVDS 05 switcher and up to 90 inputs when 10 RCVDS switchers are linked via the expansion modules.
- Serial communication with the projector.
- Remote control buttons on the RCVDS to control the projector (source selection and analog settings)
- The selected source number will be displayed on a 2 digit display and the selected input modules will be indicated with a LED on the rear.

For more information about the use of the RCVDS 05, consult the Owner's Manual, order number: R5975765.

**Connecting a VS05 switcher to the projector.**

The VS05 can switch up to 5 Composite Video sources, 3 S-Video Sources and 1 RGB analog or component Video source to the projector. In addition, the audio signal proper to the source, can be switched to an audio amplifier.  
 Order number : R9827890.

For more information about the use of the VS05, consult the Owner's Manual, order number: R5975245.

**Connecting an IR Remote Receiver to the projector**

This infra-red receiver unit makes it possible to control the projector from another room. There is a communication line cable between the IR receiver and the projector or the RCVDS. The infrared control information from the Remote Control Unit is sent to the IR Remote Receiver. The IR Remote Receiver 800 displays the selected source on a 7-segment display.  
 Order number : R9827515.

## 4

## CONTROLLING

**Caution** : Do not display a stationary image with full brightness and contrast for longer than 20 min., otherwise you risk damage to the CRT's.

### Battery installation in the RCU.

A new battery is delivered inside the plastic bag with the power cord. Before using the RCU, install first the battery.

Remove the battery cover on the backside of the remote control by pushing the indicated handle a little to the bottom of the RCU. Lift up the top side of the cover at the same time (fig. 1).

Insert the new 9 V battery (E-block type, e.g. 6F22S or equivalent) in the lower compartment and connect the battery to the contact plate.

Insert the battery into the lower compartment and put the cover back.

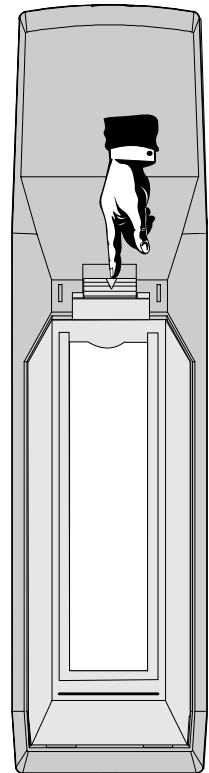
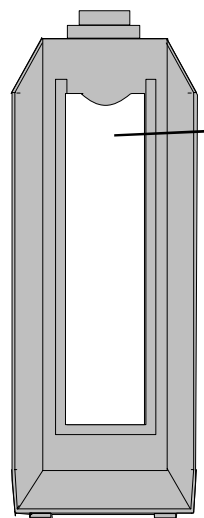
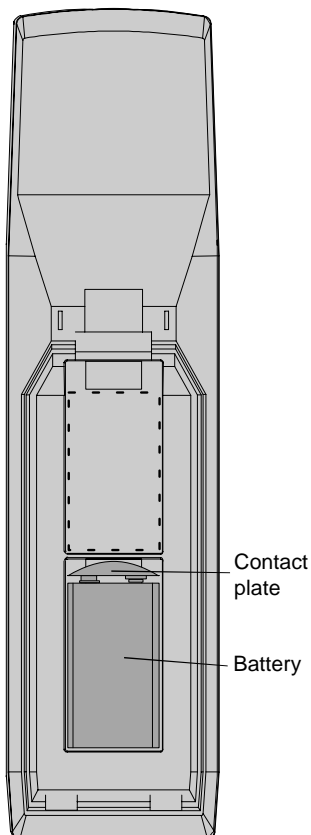

fig.1



Insert here, behind the plastic cover, the 'Insert card for RCU'. You can cut out this card on one of the last pages of this manual.

fig.2

310a.DRW

## Controlling

The projector can be controlled with

- The RCU
- The hardwired RCU (cable not included)
- The local keypad.

Controlling the projector with the RCU and the hardwired RCU is the same.

### How to use the RCU

- Point the front of the RCU towards the reflective screen surface

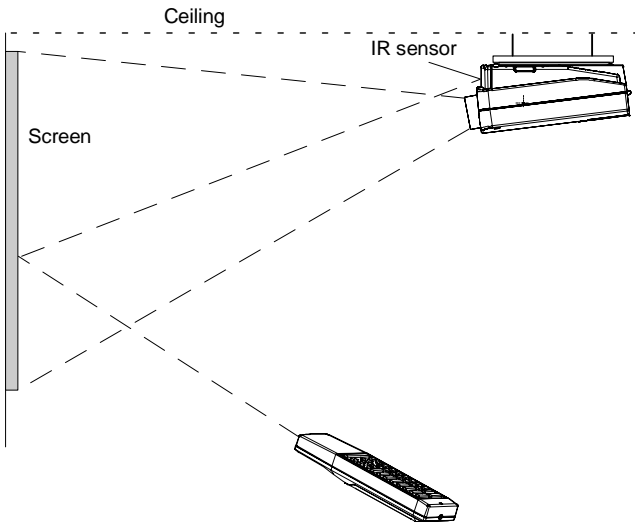

- Point the front of the RCU towards one of the IR sensors in the projector.

When using the wireless remote control, make sure you are within the effective operating distance (30m, 100ft in a straight line). The remote control unit will not function properly if strong light strikes the sensor window or if there are obstacles between the remote control unit and the projector's IR sensor.

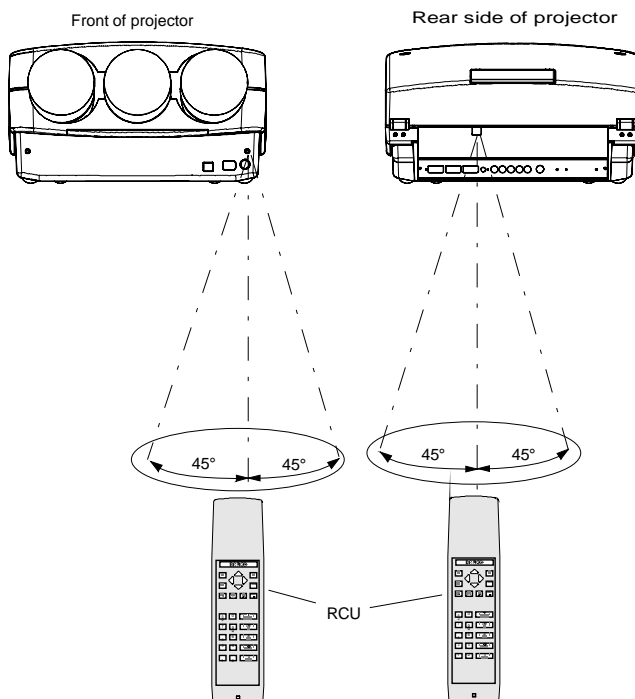

- RCU used in a hardwired configuration.

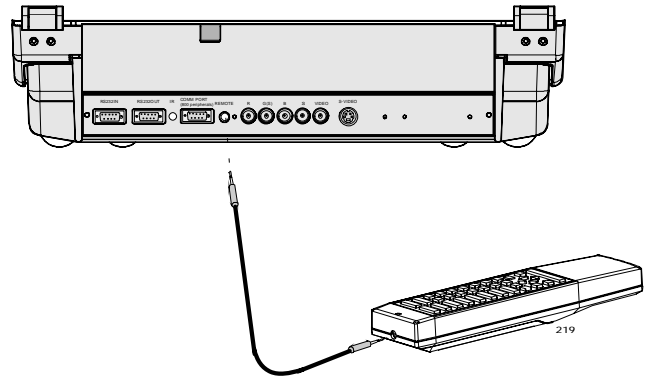

Plug one end of the remote cable in the connector on the bottom of the RCU and the second side in the connector in the rear panel of the projector labelled 'REMOTE'.

### Projector address

#### a. Software set up of the projector address.

See 'Change Projector Address' in chapter 'Service mode'. Every projector requires an individual address between 0 and 255 which is set in the Service mode. Only projectors with addresses between 0 and 9 can be controlled with the RCU.

#### b. How to control the projector.

The projector's address may be set to any value between 0 and 255. When the address is set, the projector can be controlled with :

- the RCU for addresses between 0 and 9.
- Computer, e.g. IBM PC (or compatible), Apple MAC, etc. for addresses between 0 and 255.

Note : A projector will respond to an RCU set to an address of '0' regardless of what address is set in the projector itself.

#### c. Using the RCU.

Before using the RCU, it is necessary to enter the projector address into the RCU (only when that address is between 1 and 9). The projector with the corresponding address will listen to that specific RCU.

When address 0, 'zero address' is programmed into the RCU, every projector, without exception will listen to the commands given by this RCU.

### How to display a projector address?

Press the ADDRESS key (recessed key on the RCU) with a pencil. The projector's address will be displayed in a 'Text box'. This text box disappears after a few seconds.

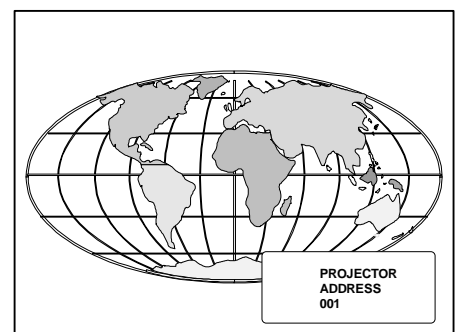

To continue using the RCU, it is necessary to enter an address with the digit buttons (address between 0 and 9). For example : if the Address key displays projector address 003, the press "3" digit button on the RCU to set the RCU's address to match the projector's address. Do not press digit 003. This will address the remote to '0' and control all projectors in the room.

### How to program an address into the RCU?

Press the ADDRESS key (recessed key on the RCU) with a pencil and enter the address with the digit buttons. That address can be any digit between 0 and 9.

### Input selection

Source No	Projector input	Press button
1	Comp. Video	1
2	S-Video/Comp. Video <sup>1</sup>	2
3	RGBS or RGsB	3
3	RGB3S or RG3sB	4
3	(R-Y)Y(B-Y)S or (R-Y)Ys(B-Y)	5
3	(R-Y)Y(B-Y)3S or (R-Y)Y3s(B-Y)	6

Two possible ways of selecting an input :

a) With the digit buttons on the RCU, it is possible to select one of the four input sources, Video, S-Video, RGsB or RGBS, RG3sB or RGB3S, (R-Y)Ys(B-Y) or (R-Y)Y(B-Y)S, (R-Y)Y3s(B-Y) or (R-Y)Y(B-Y)3S.

b) With the local keypad :  
press first the **ADJUST** key to display the *General access* menu.

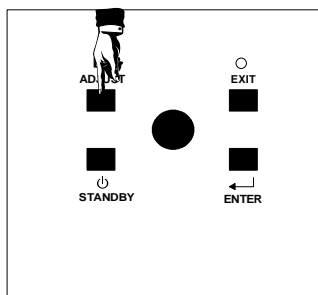

Use the control disk to highlight the desired source number. Push the control disk up or down to move the cursor up and down, push the

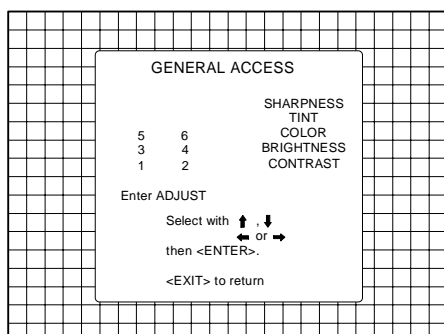

control disk to the left or to the right to move the cursor to the left and to the right.

Press **ENTER** to confirm your selection.

When a valid and available source is selected, there will be information displayed on the screen about that source. This information includes :

- Source number
- Horizontal frequency
- Vertical frequency

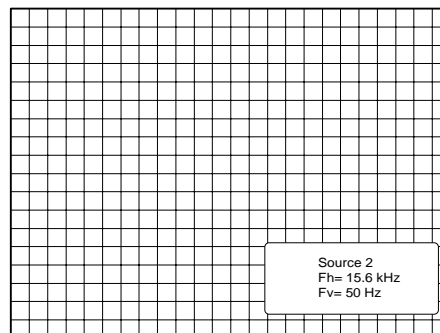

When the entry is a non valid source number, a warning appears on the screen : 'input not available'.

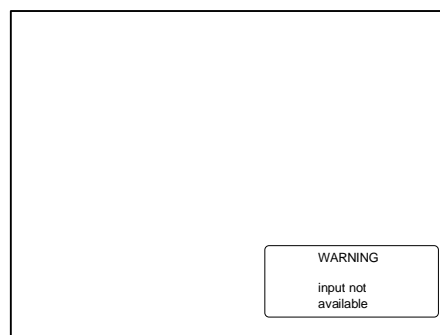

When a valid source number is selected, the projector will display this source or it will wait on the selected source number until the source becomes available. A message 'source not available' will be displayed for a short time.

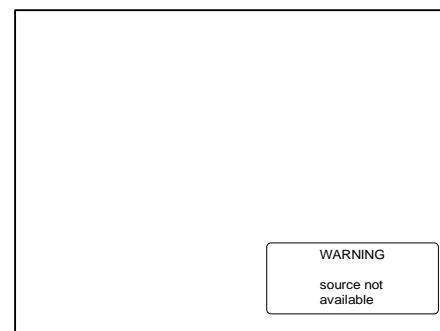

### Picture controls

The picture controls can be adjusted with :

- a) The RCU. The control keys are located on the left side of the key panel of the RCU and indicated with the name of the control and an icon.  
When an image control is pressed, a text box with bar scale and the function name of the control, e.g. 'brightness...' appears on the screen (only if text is ON). The length of the bar scale indicates the current memorized setting for this source. The bar scale changes as the + or - buttons of the control are pressed.
- b) The local keypad  
All controls are hidden in the General access menu.  
- Press **ADJUST** to display the *General access* menu.  
- Use the control disk to highlight the desired analog control and press **ENTER** to select.

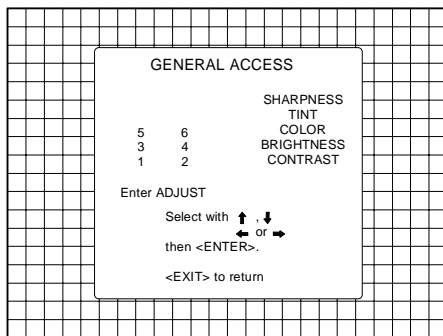
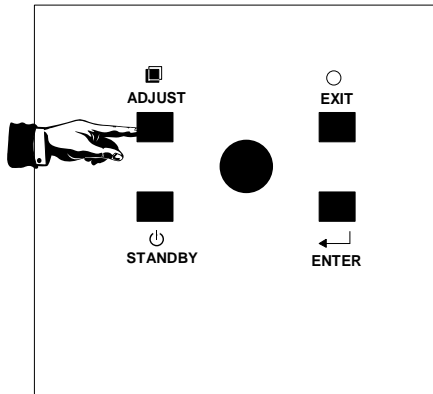

When a picture control is selected, a text box with bar scale and the function name of the control (e.g. brightness) appear on the screen. The length of the bar scale indicates the current memorized setting for this source (percentage scale). The bar scale changes as the control disk is pushed to the left or to the right.

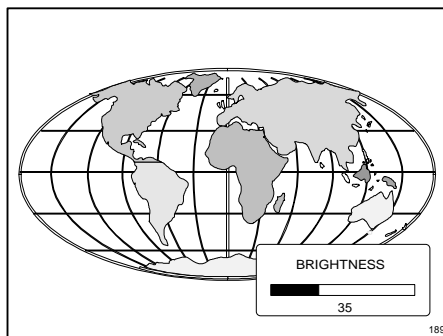

### Brightness Control

A correct 'brightness' setting is important for good image reproduction. Adjust the brightness with the + button and - button (RCU) or pushing the control disk to the left or to the right (local keypad) until the darkest parts of the picture appear black.

A bar scale gives a visual indication on the screen of the current brightness setting while pressing on the above indicated buttons. If the bar scale is not visible on the screen, press 'TEXT' once and retry the above indicated buttons.

The bar scale increases when pressing on the + button (higher brightness) and decreases when pressing on the - button (lower brightness).

### Contrast Control

A correct 'contrast' setting is important for good image reproduction. Adjust the contrast to the level you prefer, according to room lighting conditions.

A bar scale gives a visual indication on the screen of the current contrast setting while pressing the + or - buttons (RCU) or pushing the control disk to the left or to the right (local keypad). If the bar scale is not visible on the screen, press 'TEXT' key once and retry the above indicated buttons.

The bar scale increases when pressing on the + button (higher contrast) and decreases when pressing on the - button (lower contrast).

### Color Saturation Control

Color saturation is only active for Video and S-Video. Adjust the color intensity of the picture. Adjust the color saturation using the + and - buttons (RCU) or pushing the control disk to the left or to the right (local keypad). A bar scale gives a visual indication on the screen of the current color setting while pressing on the above indicated buttons. If the bar scale is not visible on the screen, press 'TEXT' key once and retry the above indicated buttons. The bar scale increases when pressing on the + button (richer colors) and decreases when pressing the - button (lighter colors).

### Tint Control

Tint is only active for Video and S-Video. Tint control is effective only when using the NTSC 4.43 or NTSC 3.58 system. A bar scale gives a visual indication on the screen of the current tint setting while pressing the + or - buttons (RCU) or pushing the control disk to the left or to the right (local keypad). If the bar scale is not visible on the screen, press the 'TEXT' key once and retry the above indicated buttons.

The bar scale increases when pressing on the + button and decreases when pressing the - button.

### Sharpness Control.

Sharpness control only active for Video and S-Video. A bar scale gives a visual indication on the screen of the current sharpness setting while pressing the + or - buttons (RCU) or pushing the control disk to the left or to the right (local keypad). If the bar scale is not visible on the screen, press 'TEXT' key once and retry the above indicated buttons.

The bar scale increases when pressing on the + button (sharper picture) and decreases when pressing on the - button (softer picture).

### The Pause key.

When the Pause key is pressed, the image projection is stopped but the projector remains with full power for immediate restart.

To restart the image :

- Press the Pause key,
- Select a source number.

# 5

## START UP OF THE ADJUSTMENT MODE

### Adjustment mode

All picture geometry and convergence adjustments are made while in the 'Adjustment mode'. Two possible ways to enter the adjustment mode :

a) Using the RCU.

Press the **ADJUST** key.  
The projector displays the path selection menu.

b) Using the local keypad.

Press the **ADJUST** key.  
The projector displays the *General access menu*.

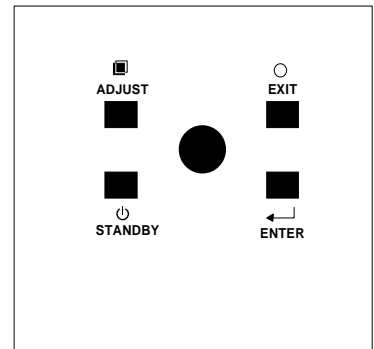

Use the control disk to highlight *enter ADJUST* and press **ENTER**. The path selection menu will be displayed.

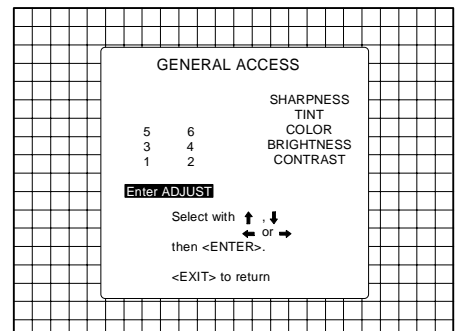

Note : to adjust the Analog picture control while in the 'Adjustment mode', press the **ADJUST** key. The next General Access menu will be displayed.

Push the control disk up or down to select the analog control to be adjusted and press the **ENTER** key to confirm.

When the analog control is adjusted the projector returns automatically to the General access menu. When you want to return to the Adjustment mode, press **EXIT**, otherwise select *quit ADJUST* and press **ENTER** to return to operational mode.

You are now in the 'Adjustment mode'. The control disk is used to make menu selections and also vertical and horizontal adjustments. The **ENTER** and **EXIT** keys are used to move forward and backward through the menu structure. The **ADJUST** key can be used to terminate the adjustment mode while a path selection menu (head menu) is displayed.

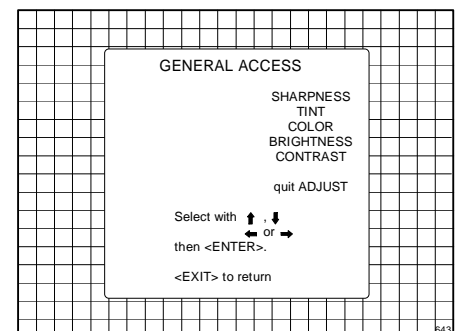

There are 5 possible paths to follow once in the Adjustment mode. They are :

**INSTALLATION** - Installation should be selected if the projector has been relocated and/or a different screen size is desired.

When selecting 'Installation', the user or operator will be warned to call a qualified technician to perform the installation procedure (see example of projected warning on next page).

**GUIDED** - Guided should be selected if the user intends to perform a complete alignment of the projected image. All of the necessary geometry and convergence adjustments are made in a predetermined sequence.

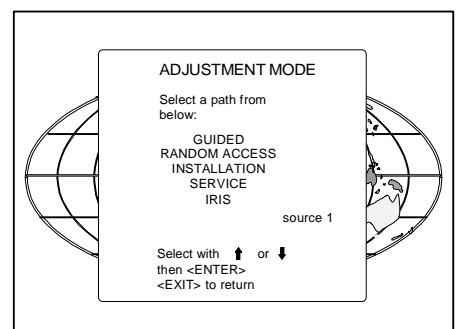

## Safety Instructions

**RANDOM ACCESS** - Random Access should be selected if the user intends to make only a few adjustments.

**SERVICE** - Service should be selected if the user intends to delete blocks, change password or apply information.

**IRIS** - This selection will only be available when the autoconvergence unit IRIS is connected to the projector.

While in Guided or Random Access adjustment Mode, the user may use an external source, an internally generated genlocked pattern or an internally generated multifrequency cross hatch pattern as a setup pattern.

### Warning during the start up of the installation mode

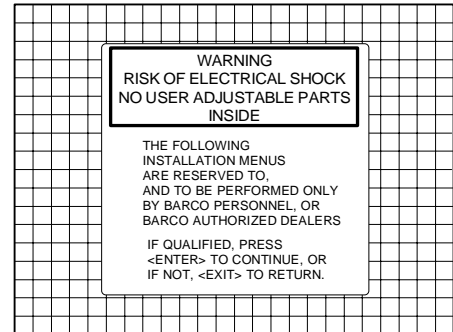

Some items in the Adjustment mode are password protected. While selecting such an item, the projector asks you to enter your password. (Password protection is only available when the password DIP switch on the controller module is in the ON position. Contact a BARCO authorized technician when no password is requested during the adjustment procedure and password protection is desired.) Your password contains 4 digits.

a) Adjusting the projector with the RCU.

Enter the digits with the numeric keys on the RCU.

Example : 2 3 1 9

For each digit entered, a 'X' appears on the screen under the displayed text 'enter password'.

When your password is correct, you get access to the 'Adjustment mode'. When the entered password is wrong, The message 'Wrong password !!!' will be displayed. The projector stays on the previous selected item.

Factory programmed password : **0000**

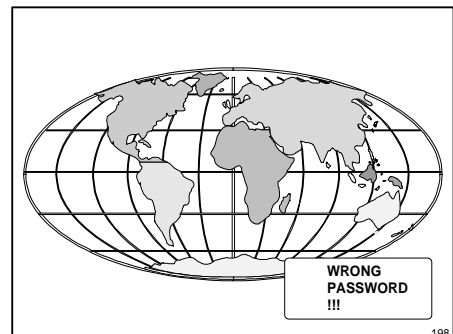
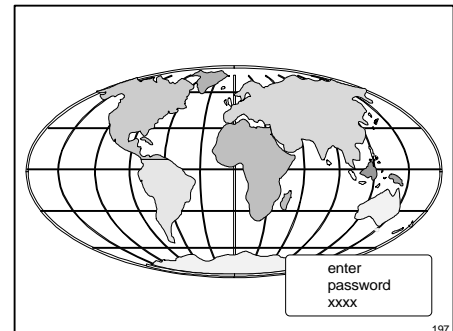

b) adjusting the projector with the local keypad.

When the 'compose password' menu is displayed, select with control disk the first digit of your password and press **ENTER**. Continue by selecting the second digit with the control disk and press **ENTER**. Handle in the same way for the third and fourth digit.

When your password is correct, you get access to the 'Adjustment mode'.

When the entered password is wrong, the message 'Wrong password' will be displayed.

Once the password is correctly entered, all other password protected items are accessible without re-entering your password. When re-entering the adjustment mode, it will be necessary to enter your password again when selecting a password protected item.

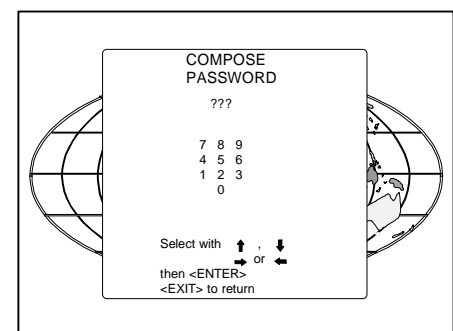

# 6

## RANDOM ACCESS ADJUSTMENT MODE

### Starting up the random access adjustment mode.

Push the control disk up or down to highlight "RANDOM ACCESS" and then press **ENTER**.

Some items in the Random access mode are password protected (when the password function is enabled). Enter your password to continue. All other password protected items are now also available if you stay in the adjustment mode.

**ENTER** continues to Setup Pattern Selection  
**EXIT** returns to operational mode

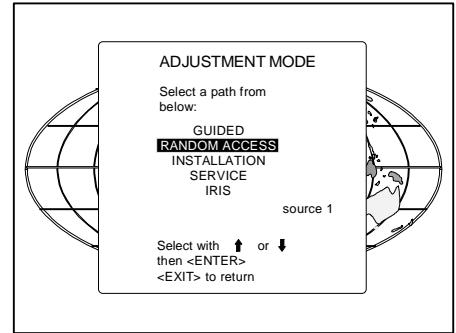

### Overview 'random Access Adjustment' mode.

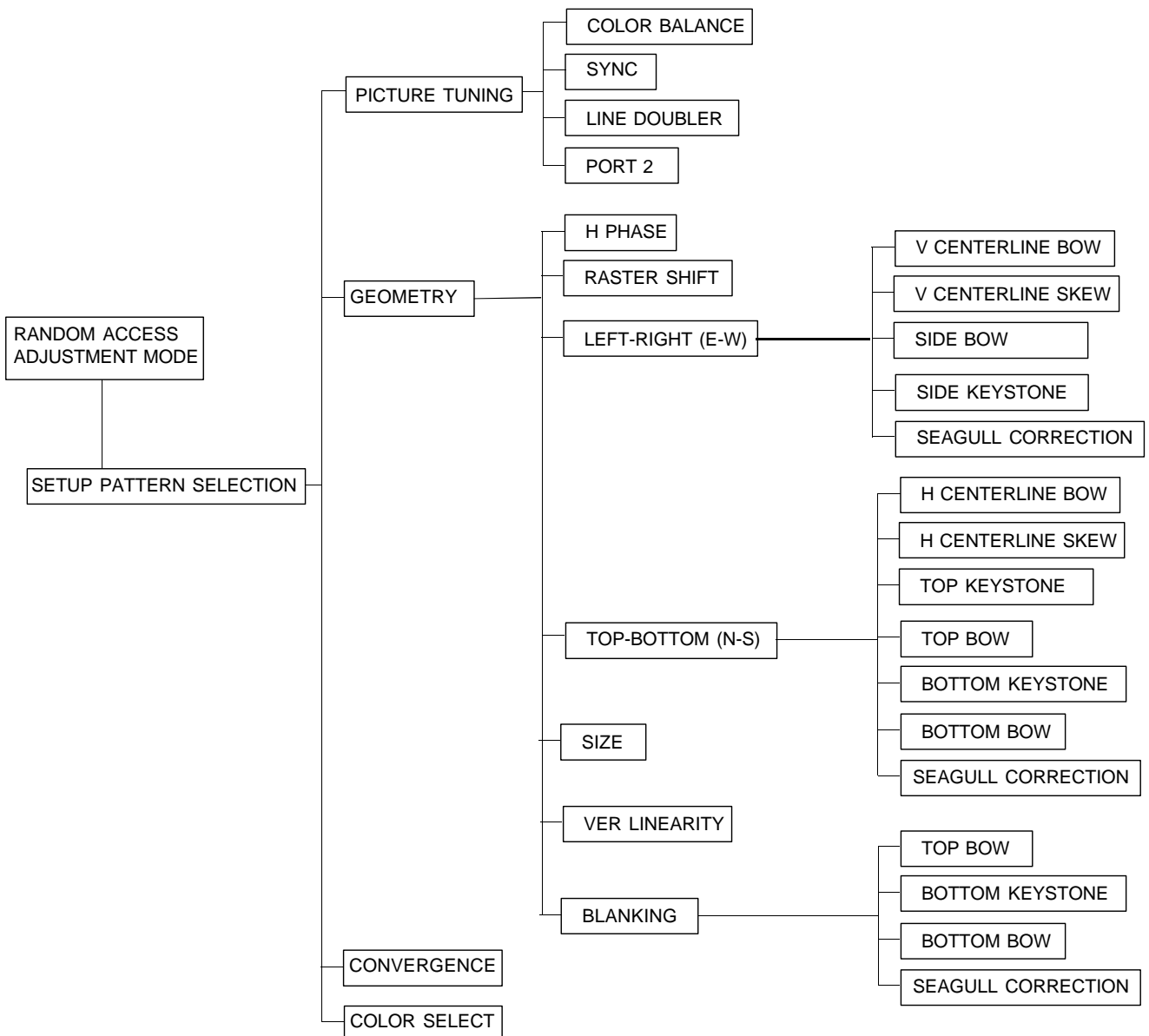

### Selecting Setup Pattern

If an external source is connected to the projector, this menu will be displayed. Push the control disk up or down to highlight the desired setup pattern and then press **ENTER**.

*Genlocked pattern : internally generated cross hatch pattern, locked on the external source.*

*Internal # pattern : internally generated cross hatch pattern and locked on internal generated sync signals. (No external source necessary)*

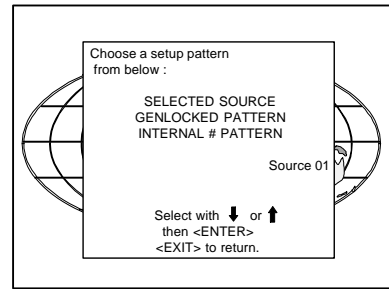

**ENTER** continues to Random Access Adjustment Mode or Internal # Pattern Selection  
**EXIT** returns to Path Selection menu  
**ADJUST** returns to Operational mode

If no external source is connected to the projector, the internal cross hatch pattern menu will be displayed.

*Note: The menus in this manual are created for an external source, connected to one of the inputs, and the 'Genlocked Pattern' is selected.*

### Internal Cross Hatch Pattern

The Internal # pattern menu will be displayed if the internal cross hatch pattern has been selected or if no source is connected to the projector.

The table below lists the 8 fixed factory preset frequencies available. Another 8 blocks are custom programmable.

Push the control disk up or down to highlight the desired cross hatch frequency. Push the control disk to the left or to the right to scroll to another page. Press **ENTER** if the desired block is selected.

kHz/Hz

15.6/50	PAL/SECAM
15.7/60	NTSC
31.2/50	EDTV
31.5/60	IDTV
31.2/50	HDTV EUREKA
31.5/60	HDTV ATV
33.7/60	HDTV HISION
15.8/60	EGA 1
21.8/60	EGA 2
31.5/60	VGA 3
31.5/70	XGA 1, 2
35.5/87	VGA 4
44.2/70	SUPER VGA 2
48.5/60	SUPER VGA 1
61.0/76	SUPER VGA 3
63.9/76	APOLLO

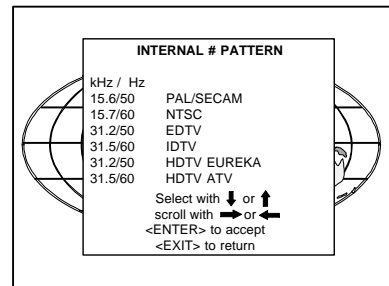

**ENTER** continues to the Random Access Adjustment Mode.  
**EXIT** returns to the Setup Pattern Selection menu.

## Random access adjustment mode selection menu.

This is the main menu for the Random Access adjustment mode.  
Through this menu, the following adjustments and features are accessible :

- Picture Tuning
  - Slot 2 : S-Video/Video
  - Sync slow/fast(video/s-video)
  - Color Balance
- Geometry
- Convergence
- Color select

And also Orbiting, Contrast modulation and Soft Edge if these options are installed.

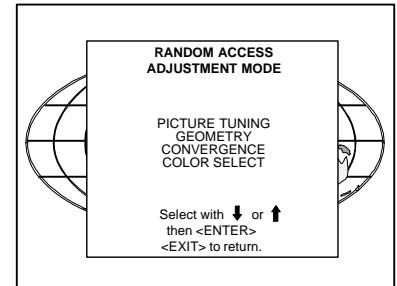

## Picture Tuning

Highlight *Picture tuning* by pushing the control disk up or down and press **ENTER**.  
The Picture tuning menu will be displayed.  
Depending on the input source, the 'Picture tuning' menu will display different items.

- Color Balance
- Sync slow/fast
- Line doubler
- Port 2 : S-Video

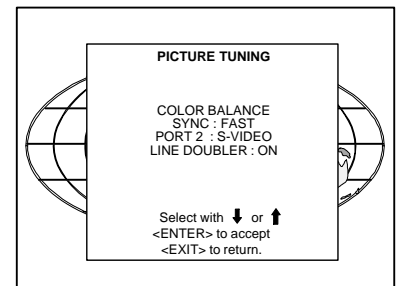

## Color Balance

The Color Balance function is used to select or adjust the color temperature of white used by the projector.

The Color Balance can be adjusted on two different ways :  
- fixed color balance. You have the choice between 3200 K (reddish), 4900 K, 6500 K (white) or 9300 K (bluish).  
- Custom white and black balance.

### Fixed Color Balance.

Highlight *one of the 4 preprogrammed color temperatures* with the control disk and press **ENTER** to display the desired color balance.

### Custom Color Balance.

Select custom white balance by pushing the control disk up or down and press **ENTER** to start the adjustment.

Push the control disk up or down to adjust the red gain and push the control disk to the left or to the right to adjust the blue gain. A bar scale indicates the amount of adjustment.

Select custom black balance with the control disk and press **ENTER** to start the adjustment.

Push the control disk up or down to adjust the red cut-off and push the control disk to the left or to the right to adjust the blue cut-off.

When the color balance is adjusted, select continue by pushing the control disk up or down and press **ENTER**.

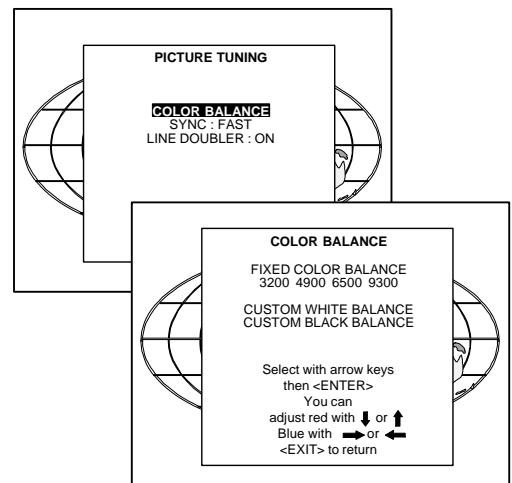

## Sync Fast/Slow Adjustment

The sync function is used to minimize horizontal jittering or tearing at the top to the displayed image.

Highlight *SYNC* with the control disk and press **ENTER** to toggle between *FAST* and *SLOW*.

*Note: SYNC is normally used in the SLOW position. The FAST position is used to compensate for unsteady sync pulses from older video playback equipment.*

Hint : when the line doubler feature is ON (active), toggle the sync to FAST.

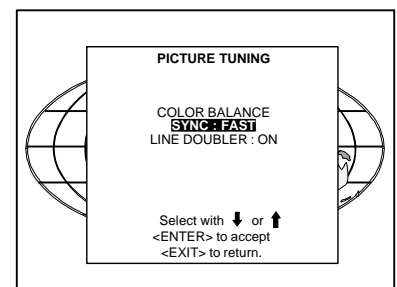

**ENTER** will toggle Sync between FAST and SLOW  
**EXIT** will return to the Random Access Adjustment menu.

### Line Doubler (option)

Line doubling is only possible for Video, S-Video, Component Video images on standard line frequency and RGB signals on 15 kHz.

To eliminate the video line patterns and to improve the image stability, the line doubler has to be switched on. The line doubler is default set in the ON position when starting up for the first time. The setting of the line doubler will be saved together with the source number. Each time this source number is selected, the last saved version will be loaded.

Highlight Line Doubler with the control disk and press **ENTER** to toggle between ON (active) and OFF (non active).

**EXIT** will return to the random access selection menu.

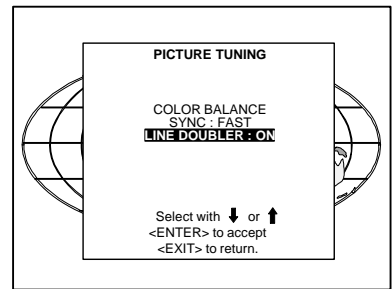

### Port 2 : S-Video/Video

Port 2 can be used as Video or S-Video input.

Highlight *Port 2* by pushing the control disk up or down and press **ENTER** to toggle between *Video* and *S-Video*.

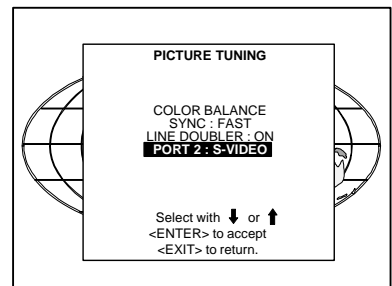

### Peaking

Peaking improves the contours in an projected image.

Highlight *PEAKING* by pushing the control disk up or down and press **ENTER** to toggle the peaking between OFF and ON.

During the creation of new settings for a RGB source the peaking is switched to OFF.

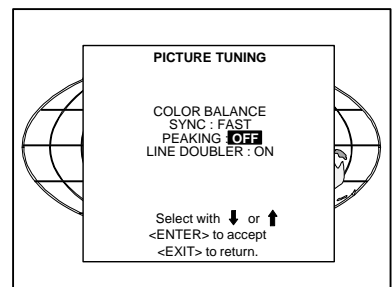

### Color Select

Highlight *COLOR SELECT* by pushing the control disk up or down and press **ENTER** to display the color select menu.

**ENTER** continues to the color select menu.  
**EXIT** will return to Internal Crosshatch Selection or Setup Pattern Selection Menu.  
**ADJUST** returns to operational mode.

Use the control disk to highlight a color (CRT) or combination of colors to display the projected image in that specific color.

To select a new color, press **ENTER**, the color selection menu appears again on the screen. To terminate the color select procedure, press **EXIT**.

**ENTER** continues with the selected color or color combination.  
**EXIT** returns to the Random access main menu.

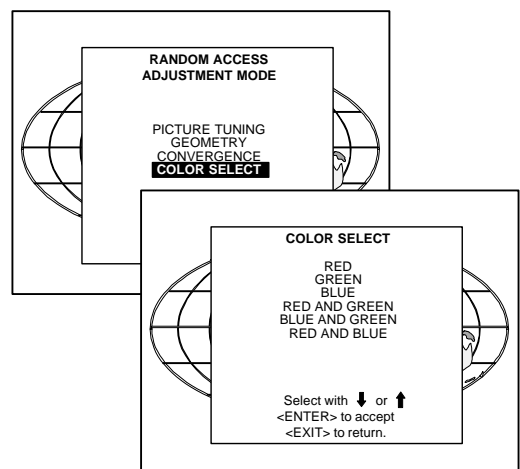

## Geometry Adjustments

The geometry adjustments have to be done only on the green image. These adjustments are automatically implemented for the other color images : Left-right (EW) and Top-Bottom Corrections, Blanking, Horizontal Amplitude, Vertical Amplitude, Vertical Linearity and Horizontal Phase.

Highlight *GEOMETRY* by pushing the control disk up or down and press **ENTER** to display the geometry menu.

**ENTER** will display Geometry menu.  
**EXIT** will return to Internal Crosshatch Selection or Setup Pattern Selection Menu.  
**ADJUST** returns to operational mode.

Within the Geometry Adjustment menu, the following adjustments are available :

- Horizontal Phase (not for internal # pattern).
- Raster Shift
- Left-Right Corrections
- Top-Bottom Corrections
- Horizontal Size
- Vertical Linearity
- Vertical Size
- Blanking

The convergence corrections are disabled during geometry corrections. The blanking corrections are only enabled during the blanking adjustments.

### Horizontal Phase Adjustment

Push the control disk up or down to highlight *H PHASE* on *Geometry menu* and then press **ENTER**.

Note : No horizontal phase adjustment is available on the internal # pattern.

For external sources :

If the raster shift is correctly adjusted, the H Phase text box is projected in the middle of the raster. At that moment, the "><" icon indicates the middle of the raster.

Adjust the H Phase control until the middle of the projected image is equal with the middle of >< icon.

Note :

- If the genlocked pattern was selected, the external source will be displayed.

A bar scale and a number indicator (between 0 and 100) on the screen give a visual indication of the horizontal phase adjustment.

**ENTER** continues to geometry menu .

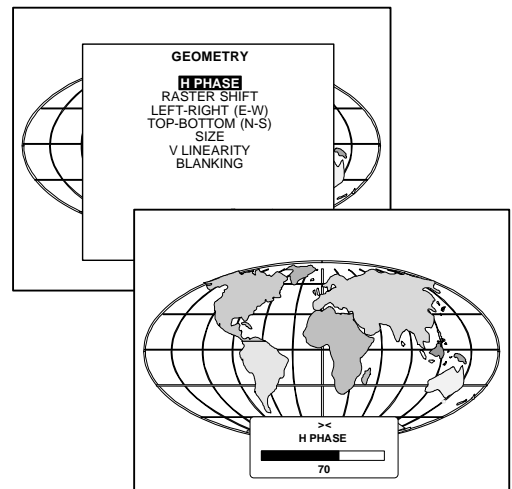
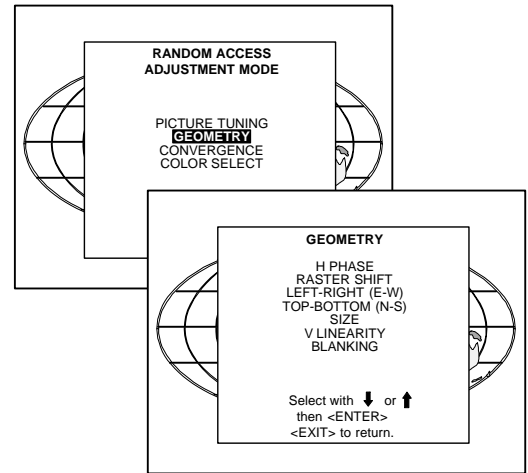

Push the control disk to the right to correct

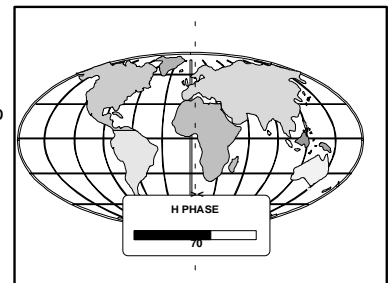

Push the control disk to the left to correct

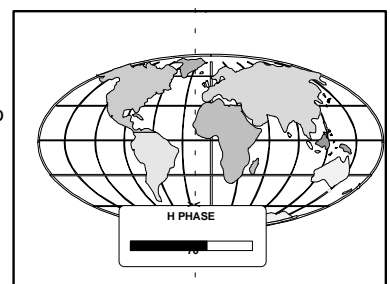

Raster Shift Adjustment

The green raster must be centered both horizontally and vertically on the center of the CRT surface. To center the green raster, look into the green lens and use the control disk to move the raster.

CAUTION

It is necessary to look into the lenses to perform these adjustments. To avoid eye discomfort while looking into the lenses, reduce the contrast and gradually increase the brightness level until the raster becomes visible on the face of the CRT.

**ENTER** will select green raster shift adjustment  
**EXIT** returns to random access adjustment mode menu.

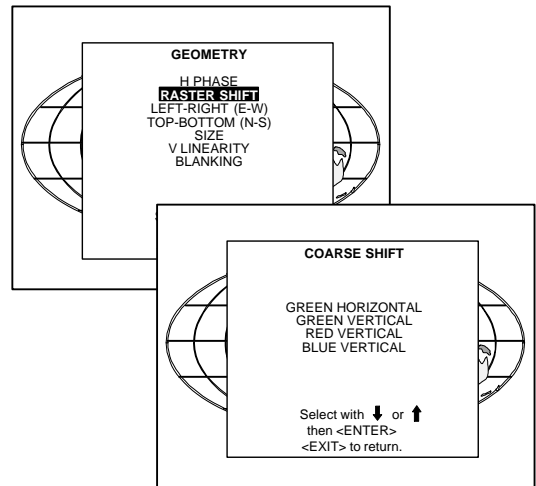

**Warning :** In order to ensure maximum CRT longevity and to avoid CRT damage, do not shift the raster outside the phosphor area of the CRT.

To start the adjustment, use the control disk to highlight Raster shift and press ENTER to display the green raster on the phosphor.

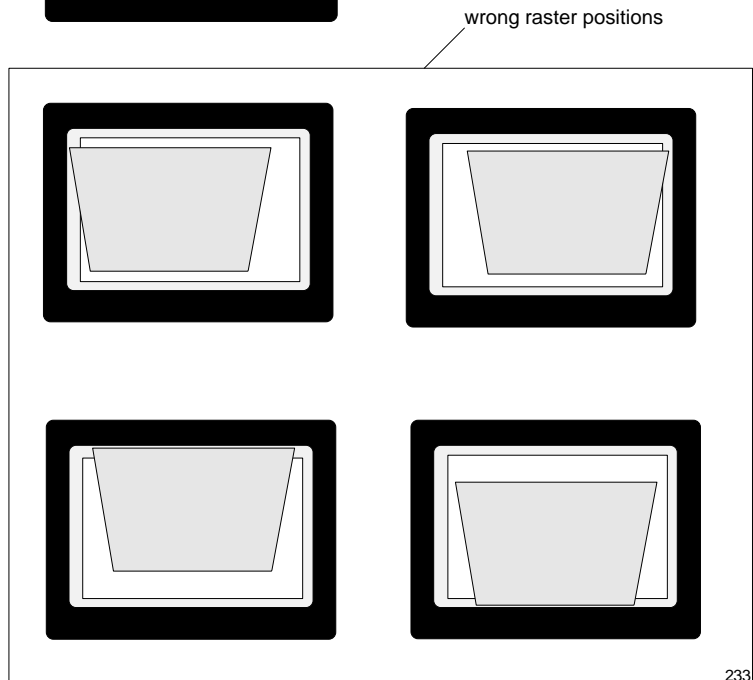
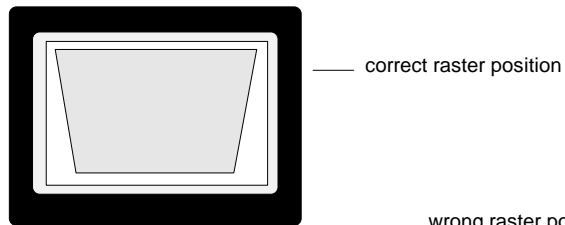
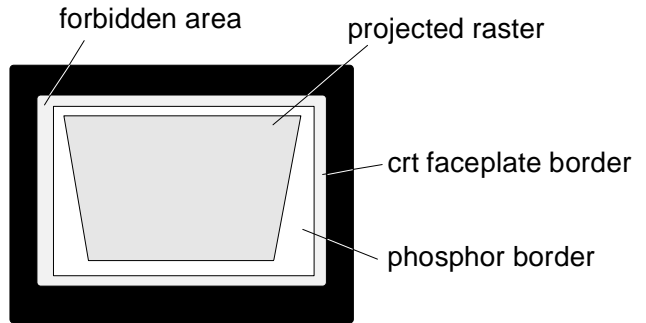

Press **EXIT** to return to the Geometry menu.

Note : Horizontal and Vertical shifts for Red and Blue should end up with a setting close to 50%. If these settings are significantly greater or lesser than 50%, contact a BARCO authorized service technician.

### Left-Right (east-west) Adjustments

Left-right and center adjustments affect only the vertical lines of the projected image.

To start up the left-right and center adjustments, follow the next procedure :  
 Push the control disk up or down to highlight *LEFT-RIGHT (E/W)* on the geometry menu and then press **ENTER**.

**ENTER** will select Left-Right adjustment menu  
**EXIT** returns to random access adjustment mode main menu.  
**ADJUST** returns to operational mode

*Only the green image is displayed while making left-right adjustments. The red and blue images will automatically be corrected in the same manner. Convergence corrections are automatically disabled for the duration of these adjustments.*

The following adjustments can be executed

- vertical centerline bow
- vertical centerline skew
- side keystone (left - right)
- side bow (left - right)

All adjustment are indicated on the screen with the function name, a bar scale and a number between 0 and 100.  
 Adjust the next alignments until the vertical lines are straight.  
 To enter an alignment, push the control disk up or down to highlight a function and press **ENTER** to activate this function.  
 Press **EXIT** to return.

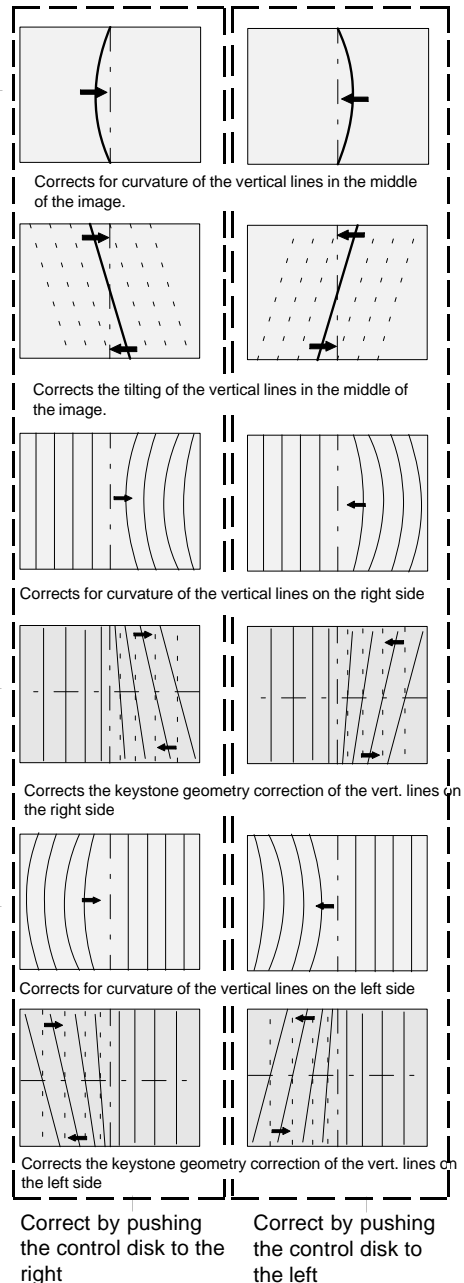
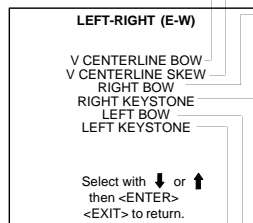
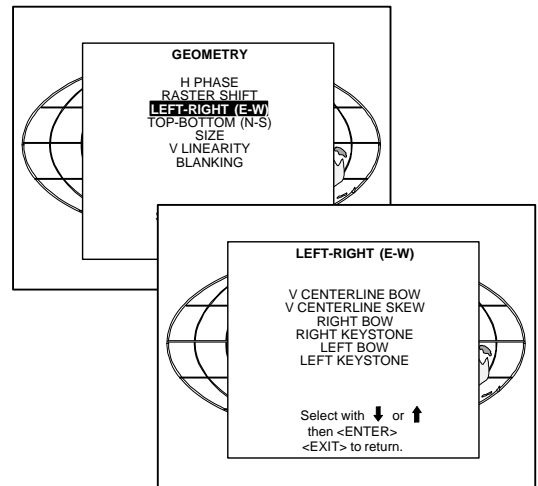

### Top-Bottom (north-south) Adjustments

Top-Bottom and center adjustments affect only the horizontal lines of the projected image.  
 To start up the Top-Bottom and center corrections, follow the next procedure :

Push the control disk up or down to highlight *TOP-BOTTOM (N/S)* on the geometry menu and then press **ENTER**.

*Only the green image is displayed while making top-bottom adjustments. The red and blue images will automatically be corrected in the same manner. Convergence corrections are automatically disabled for the duration of these adjustments.*

The following adjustments can be executed :

- Horizontal centerline bow
- Horizontal centerline skew
- Top bow
- Top keystone
- Bottom bow
- Bottom keystone

All adjustment are indicated on the screen with the function name, a bar scale and a number between 0 and 100.

Adjust the next alignments until the vertical lines are straight.  
 To enter an alignment, push the control disk up or down to highlight a function and press **ENTER** to activate this function.  
 Press **EXIT** to return.

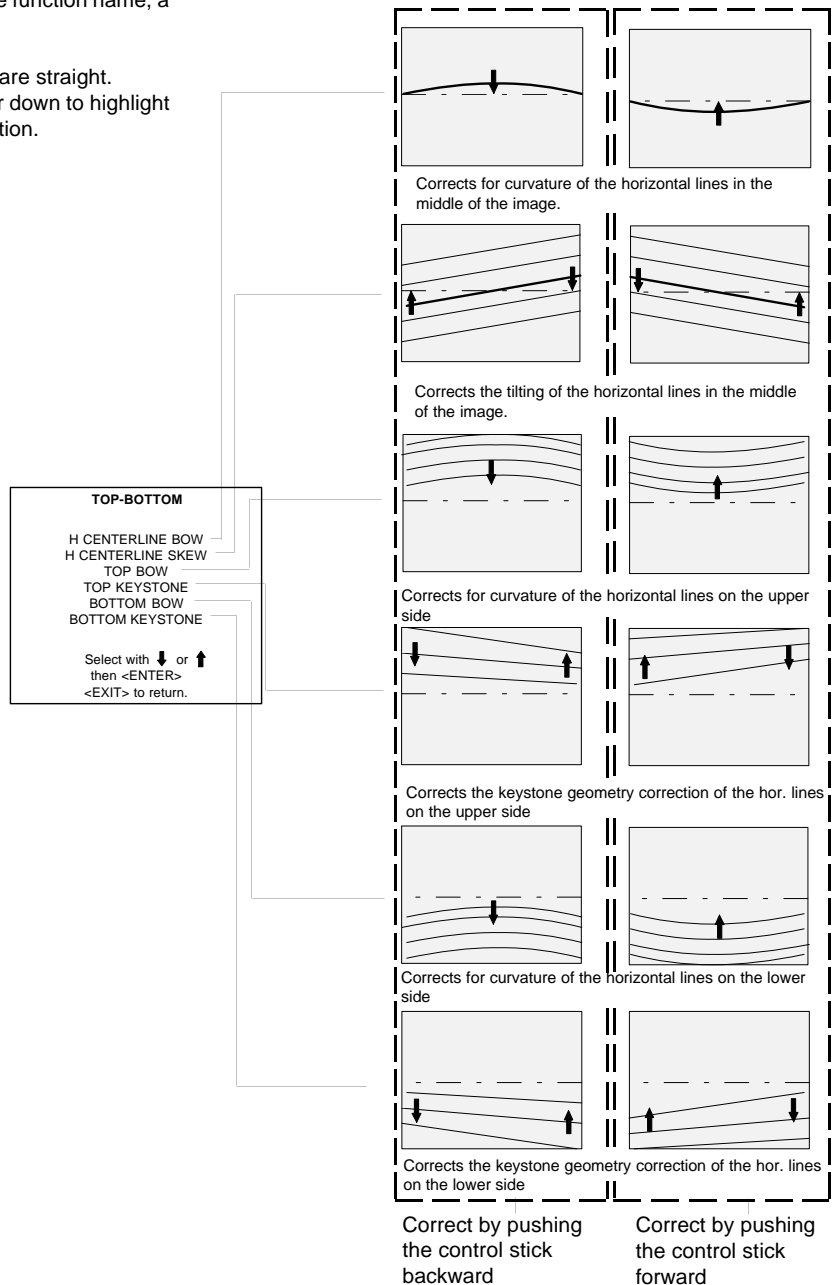
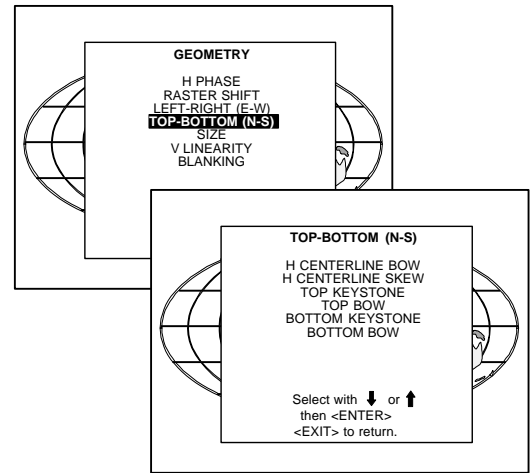

### Size Adjustment

Push the control disk up or down to highlight **SIZE** on the Geometry menu and then press **ENTER**.

**ENTER** will select size adjustment.  
**EXIT** returns to random access adjustment mode menu.  
**ADJUST** returns to operational mode.

Adjust the horizontal size by pushing the control disk to the right or to the left until the exact image width is obtained.  
 Adjust the vertical size by pushing the control disk up or down until the exact image height is obtained.

Note :  
 - If the internal # pattern was selected, this pattern remains on the screen.  
 - If the genlocked pattern was selected, the external source will be displayed.

A bar scale and a numeric indicator help to gauge the size adjustment.

*Hint : In order to avoid loss of resolution in the projected image and to ensure maximum CRT longevity, do not use an excessively small horizontal size setting.*

**EXIT** will return to Geometry.

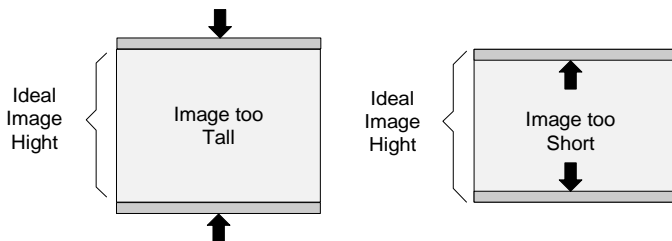
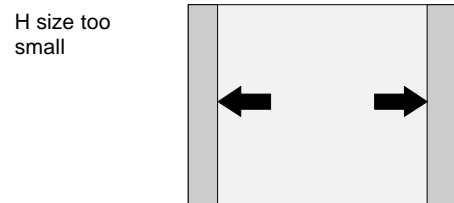
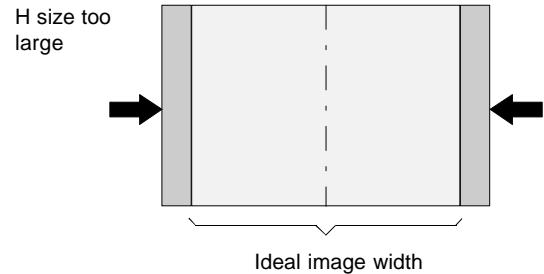
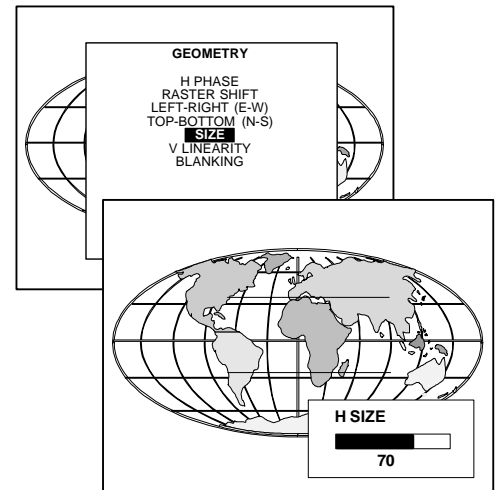

### Vertical Linearity Adjustment

The vertical linearity adjustment function corrects for vertical non-linearities which extend from the center of the image to the top and bottom of the image.

Push the control disk up or down to highlight **V LINEARITY** on the Geometry menu and then press **ENTER**.

**ENTER** will select vertical linearity adjustment.  
**EXIT** returns to random access adjustment mode menu.  
**ADJUST** returns to operational mode.

Adjust the vertical linearity with the control disk until the distances between the horizontal lines of the set up pattern are equal from top to bottom.

**EXIT** will return to the Geometry menu.

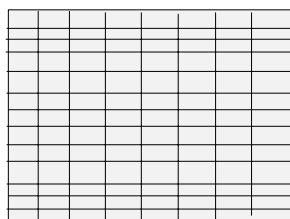
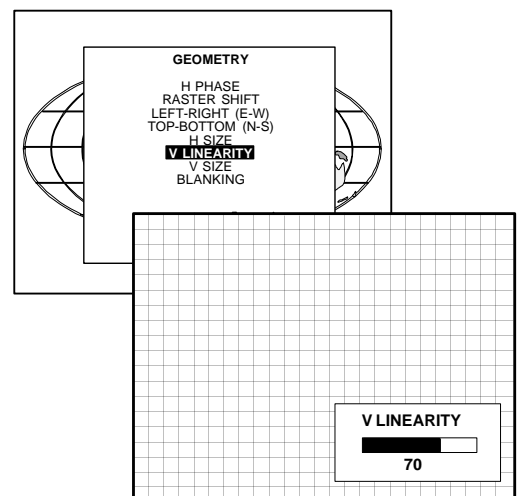

### Blanking Adjustments

Blanking adjustments affect only the edges of the projected image and are used to frame the projected image on to the screen and to hide or black out unwanted information (or noise). A 0% on the bar scale indicates no blanking.

To start up the Blanking adjustments, follow the next procedure :

Push the control disk up or down to highlight *BLANKING* on the Geometry menu and then press **ENTER**.

The following blanking corrections are possible :

- Top blanking
- Bottom blanking
- Left blanking
- Right blanking

Therefore :

- If the internal # pattern was selected, this pattern remains on the screen.
- If the genlocked pattern was selected, the external source will be displayed.

Adjust the next blanking alignments until the image is correctly framed or the unwanted information is blanked out. To enter a blanking alignment, push the control disk up or down to highlight a function and press **ENTER** to activate this function.

Press **EXIT** to return.

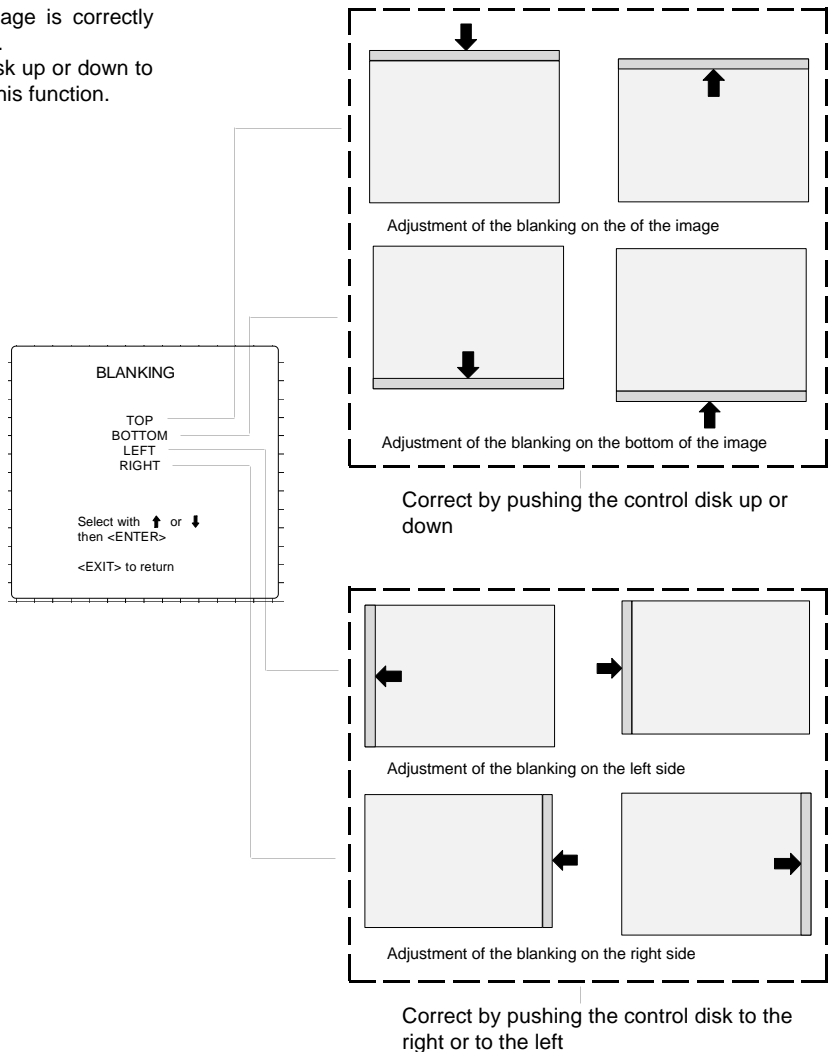
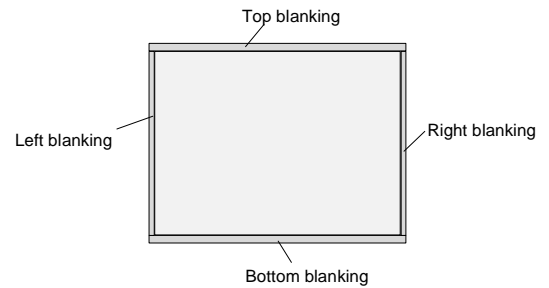
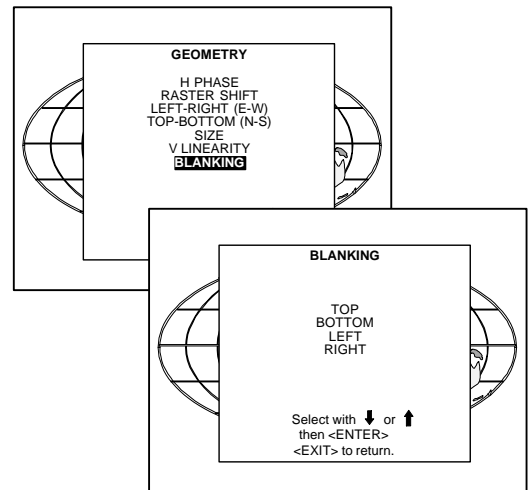

### Convergence Adjustment

Convergence adjustments affect both the horizontal and vertical lines of the setup pattern. These adjustments are performed on the red image while superimposed on the green image and then on the blue image while superimposed on the green image.

Note : the green convergence adjustments can be added as an option. When these are available, start always with 'green only'. This option will also be indicated on the convergence menu.

Highlight first 'Green only' when available by pushing the control disk up or down and press ENTER to display the convergence adjustment menu.

The screen area is divided into 25 areas.

Use the control disk to move the box to the desired zone and then press **ENTER** to begin the convergence adjustment. Start the convergence adjustment with zone one and continue as mentioned in the diagram hereafter.

Use the control disk to make horizontal or vertical convergence adjustments in the selected zone and then press **ENTER** to move the box to another zone or **EXIT** to return to the Convergence menu.

**ENTER** toggles the control disk between zone selection and zone adjustment .  
**EXIT** returns to convergence menu

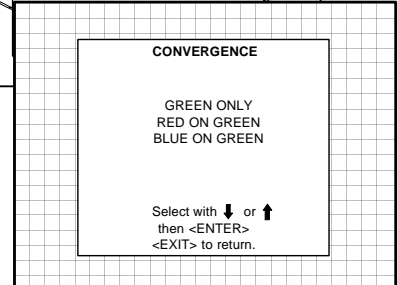
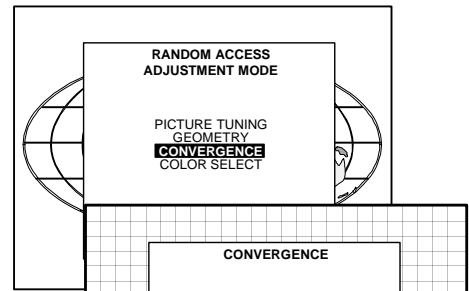
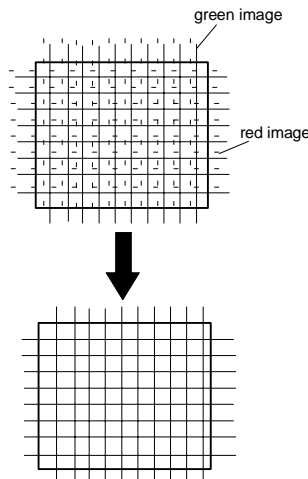

25	23	9	15	17
24	22	8	14	16
5	4	1	2	3
20	18	6	10	12
21	19	7	11	13

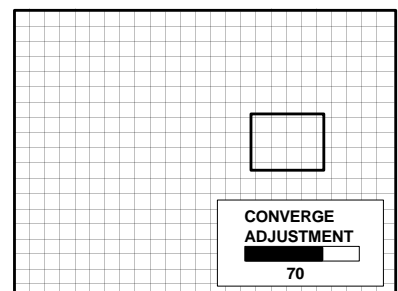
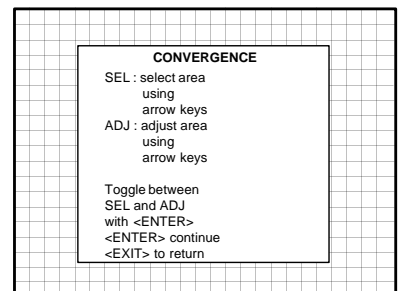



# 7

## SERVICE MODE

### Starting up the Service mode.

Use the control stick to highlight 'Service' and then press **ENTER**.

Some items in the Service mode are password protected (when the password function is active). Enter your password to continue. All other password protected items are now also available if you stay in the adjustment mode.

**ENTER** continues to the Service Mode main menu.  
**EXIT** returns to the Operational mode.

The service items are combined in two service menus. To switch from the first to the second menu or vice versa, push the control stick forward or backward to select 'more...'

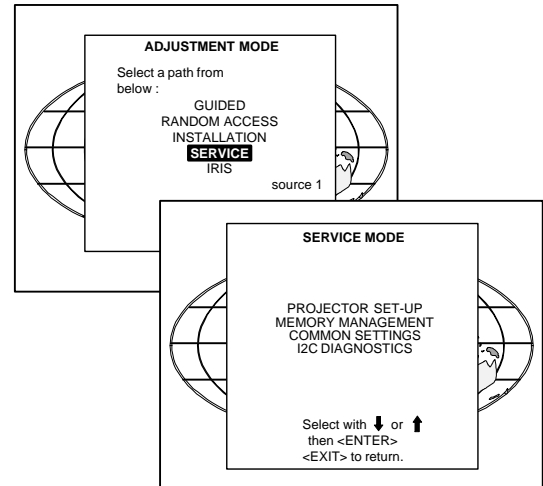

### Overview flowchart 'Service' mode.

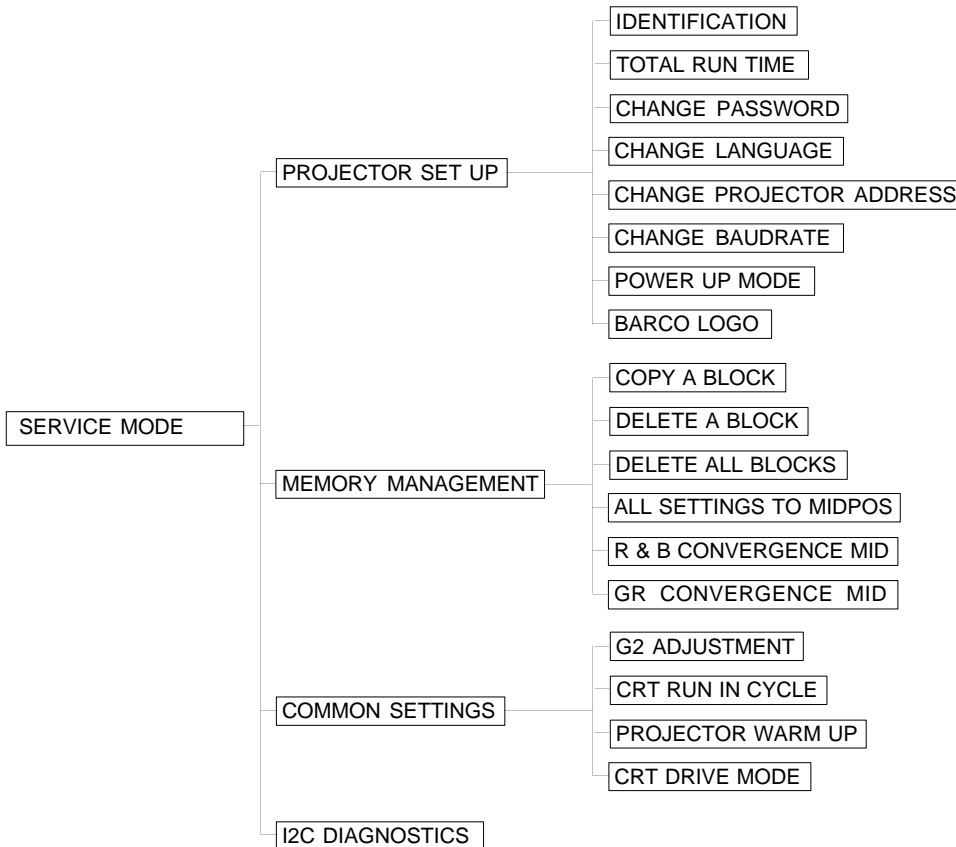

## Projector Set-up

Highlight 'Projector Set-Up' by pushing the control disk up or down and press **ENTER** to display the projector set-up menu.

Within the projector set-up menu, the following items can be consulted or set to the desired setting :

- Identification
- Total run time
- Change password
- Change language
- Change projector address
- Change baudrate
- Power up mode
- BARCO logo

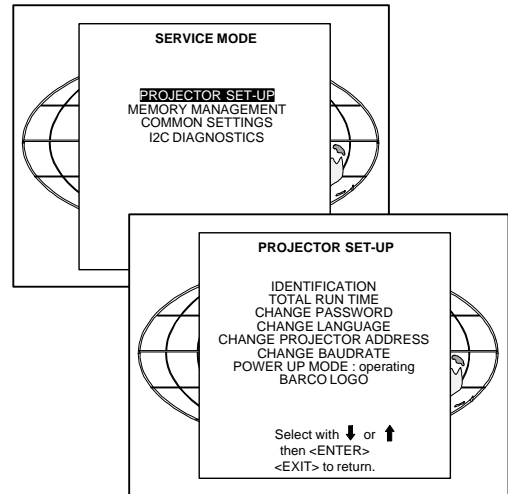

### Identification

Highlight 'Identification' with the control disk and press **ENTER**.

**ENTER** will start the selected item.  
**EXIT** returns to the Service mode menu.

The 'Identification' screen gives information concerning :

- Projector address. To change the address of your projector, contact a qualified service technician.
- Software version.
- Configuration.
  - Possible installations :
    - \* Front-ceiling
    - \* Front-table
    - \* Rear-ceiling
    - \* Rear-table
- Baud rate PC : transfer speed for communication with an IBM PC (or compatible) or MAC. The baud rate of the projector must be the same as the baud rate of the connected computer. When there is a difference, contact a qualified service technician to make the appropriate changes.
- Text ON/OFF
 

Indicates in operational mode if the bar scale and number indicator will be displayed and if warnings and failures will be displayed.

  - ON : displayed
  - OFF : not displayed

The status can be changed by pressing the 'TEXT' key once on the RCU.
- Serial no. : indicates the fabrication number of the projector. This number can be useful when calling for technical assistance.

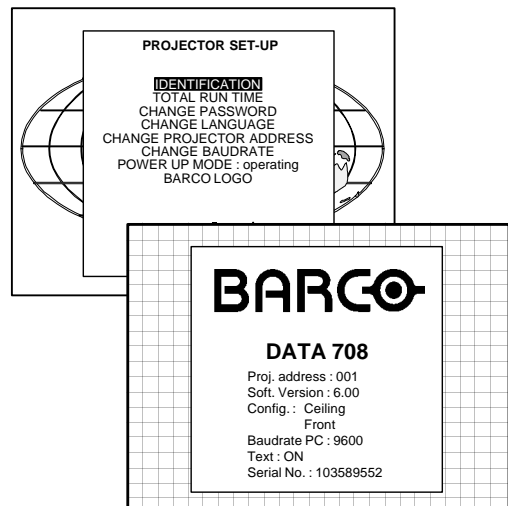

### Total Run Time

Highlight 'Total Run Time' with the control disk and press **ENTER** to display the amount of time the projector has played since its first start up at the factory.

**ENTER** gives the selected item.  
**EXIT** returns to the Service mode menu.  
**ADJUST** returns to the Operational mode.

Note : all projectors leave the factory after a burn-in period of approximately 100 hours.

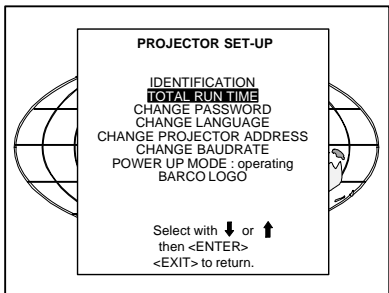

### Change password

This item is password protected. Highlight 'Change Password' with the control disk and press **ENTER**.

**ENTER** will display the selected item.  
**EXIT** will return to the Path Selection main menu.  
**ADJUST** will return to the Operational mode.

The current password is displayed. The new password must consist of 4 digits between 0 and 9. Push the control disk to the left or to the right to select the digits to be changed. Use the numeric keys to enter the new digits. Press **ENTER** to save the new password. Before saving the new password, a confirmation screen will be displayed. Press **EXIT** to return to the Projector Set-up menu without saving the new password. When the displayed password is correct, press **ENTER** to save. If not correct, press **EXIT** to cancel the saving.

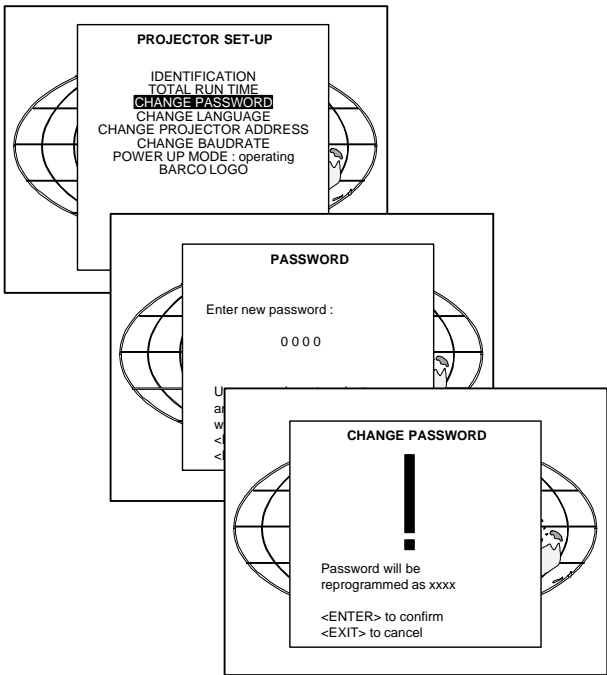

**ENTER** saves the entered password.  
**EXIT** returns without saving.

### Change Language

The 'Change Language' function offers the possibility to change the language of the screen menus to :

- English
- Spanish
- French
- German

Highlight 'Change Language' with the control disk and press **ENTER**.

**ENTER** selects the Change language menu.  
**EXIT** returns to the Service menu.

Push the control disk up or down to select the desired language and press **ENTER** to change the language.

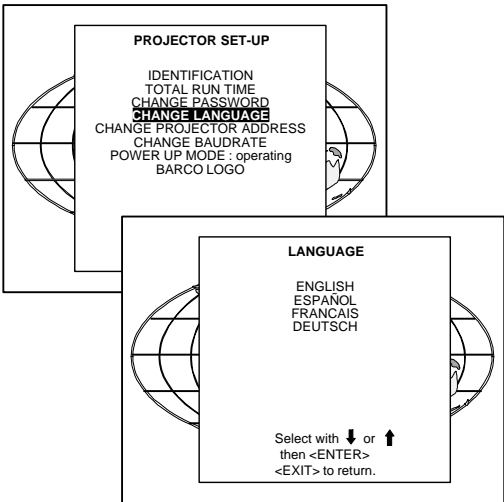

## Change Projector Address

Every projector requires an individual address between 0 and 255. This address can be software installed. To change that address, push the control disk up or down to highlight 'Change Projector Address' and press **ENTER**. The Change Projector Address menu will be displayed and the actual address will be filled in.

**ENTER** displays the 'Change Projector Address' menu.  
**EXIT** returns to the Service mode main menu.

The first digit is highlighted. Select the individual digits by pushing the control disk to the right or to the left. Reprogram with the digit keys on the RCU. Press **ENTER** to confirm. Press **EXIT** to return to the projector set up menu.

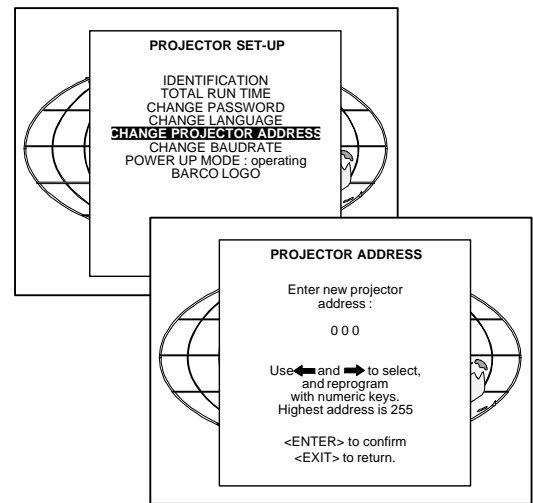

## Change baudrate

The communication speed between projector and computer has 8 possible speeds. The baud rate speed can be software set up. Highlight 'Change Baudrate' by pushing the control disk up or down and press **ENTER** to display the Baud rate menu.

The following baud rates are available :

- 9600
- 4800
- 2400
- 1200
- 600
- 300
- 150
- 110

The actual baud rate will be highlighted. To change the baud rate, push the control disk up or down or to the left or to the right to select the desired baud rate and press **ENTER** to accept this baud rate.

**ENTER** to accept the selected baud rate.  
**EXIT** to return without changing the baud rate.

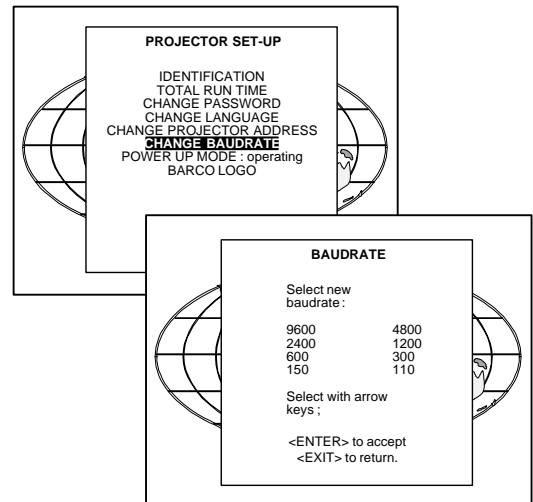

## Power up mode

When pressing the power switch, the projector can start up in 'operating mode' or in 'stand-by mode'.

Operating mode : the projector start up and displays image .

Stand-by mode : the projector start up in stand-by and waits until the stand-by button or a digit key is pressed.

To change the Power up mode, select Power Up mode by pushing the control disk up or down and press **ENTER** to toggle between 'Operating' and 'Standby'.

**ENTER** to toggle between operating and standby.  
**EXIT** to return to the Service menu.

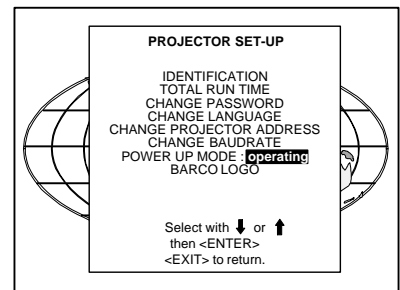

## BARCO\_logo

The BARCO logo can be added to the image, in overlay or in background, on any place on the screen.

To add the BARCO logo or to change a setting in the BARCO logo menu, highlight 'BARCO logo' by pushing the control disk up or down and press **ENTER** to select.

**WARNING : Continuous use of the BARCO logo damages the RED CRT.**

**ENTER** displays the BARCO logo menu.  
**EXIT** returns to the Service menu

The BARCO logo menu will be displayed on the screen. Within this menu, four toggle settings are available.

Mode [ON/OFF] :

ON : BARCO logo will be displayed on the screen.

To position the logo on the screen, push the control disk up, down, to the left or to the right until the desired position is reached.

OFF : No BARCO logo displayed on the screen.

Size [SMALL/LARGE] :

SMALL : Small BARCO logo will be displayed if mode is on.

LARGE : Large (double size) BARCO logo will be displayed if mode is on.

Background [ON/OFF] :

ON : BARCO logo will be displayed on a black background.

**BARCO**

OFF : BARCO logo will be displayed without any background.

**BARCO**

Orbiting [ON/OFF] :

ON : on the BARCO logo will orbit around it axis.

OFF : no orbit of the BARCO logo.

## Memory management

Highlight 'Memory management' by pushing the control disk up or down and press **ENTER** to display the memory management menu. Within the memory management menu, the following items can be consulted or executed :

- copy a block
- delete a block
- delete all blocks
- all settings to midposition
- R & B convergence to mid
- Gr convergence mid (only if green convergence is available)

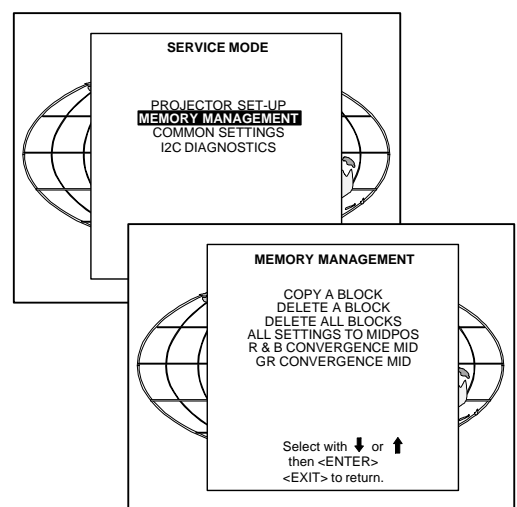
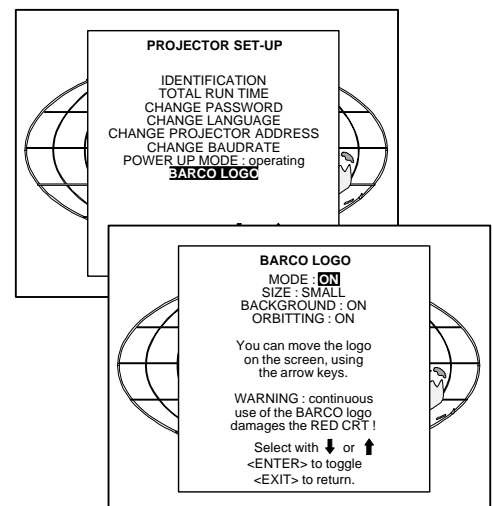

## Copy a block

The copy a block function copies the settings of a selected block into the active block.

Highlight *copy a block* with the control disk and press **ENTER**.

**ENTER** will select the highlighted item.  
**EXIT** returns to the Path Selection main menu.  
**ADJUST** returns to the Operational mode.

To copy the settings of a closed block to the block you are working on (active block), use the control disk to select a block. All existing settings will be overwritten with the new settings.

Press **ENTER** to copy the selected block. A confirmation screen will be displayed.

**ENTER** displays a confirmation screen.  
**EXIT** returns to the Service Mode main menu.

If you are certain you wish to copy the contents of the selected block into the active block, press **ENTER**.  
**EXIT** cancels the copy procedure and returns without copying the block.

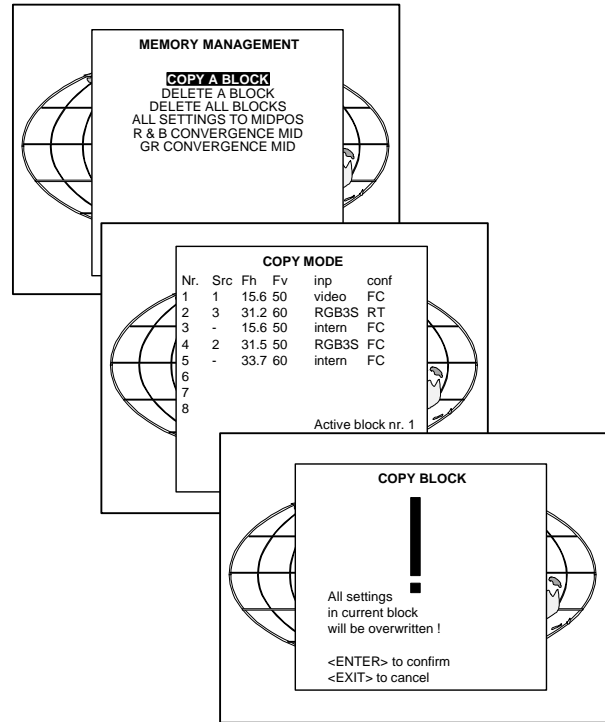

## Deletion of blocks

This item is password protected.

The delete function is used to clear all data (settings) from an adjustment block.

A delete can be given :

- block by block
- or
- for all blocks.

### Deleting block by block

The 'delete a block' function deletes the settings of a selected block. Highlight 'Delete a block' with the control disk and press **ENTER**.

**ENTER** will select the pointed item.  
**EXIT** returns to the Path Selection main menu.  
**ADJUST** returns to the Operational mode.

Push the control disk up or down to select the desired adjustment block. Press **ENTER** to delete the selected adjustment block. A confirmation menu will be displayed.

**ENTER** displays the confirmation menu.  
**EXIT** returns to the Service Mode main menu.

**ENTER** will delete the selected block.  
**EXIT** cancels the deletion procedure and returns to the Service mode main menu.

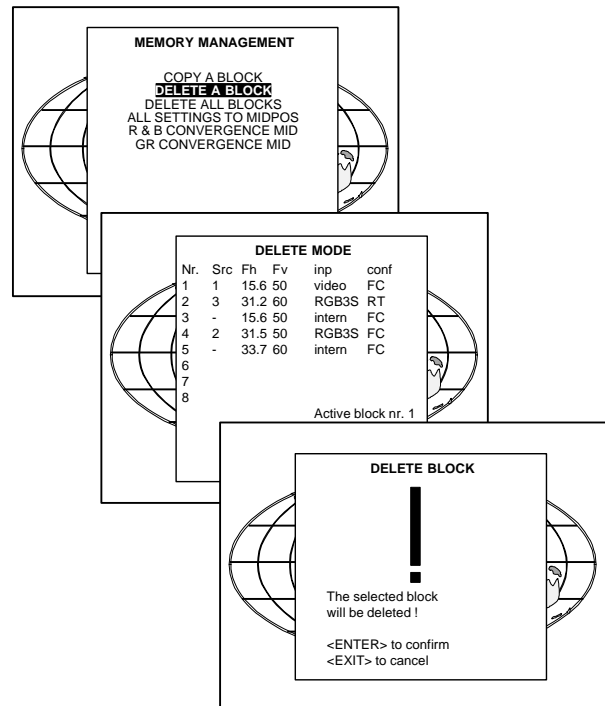

### Deletion of all blocks

Highlight '*delete all blocks*' with the control disk and press **ENTER**.

**ENTER** gives a confirmation message before deleting.  
**EXIT** returns to the Path Selection main menu.

If you are certain you wish to delete all blocks, press **ENTER** to confirm, otherwise press **EXIT** to return.  
 Once **ENTER** is pressed, all block headers and adjustment settings are permanently removed and cannot be restored.

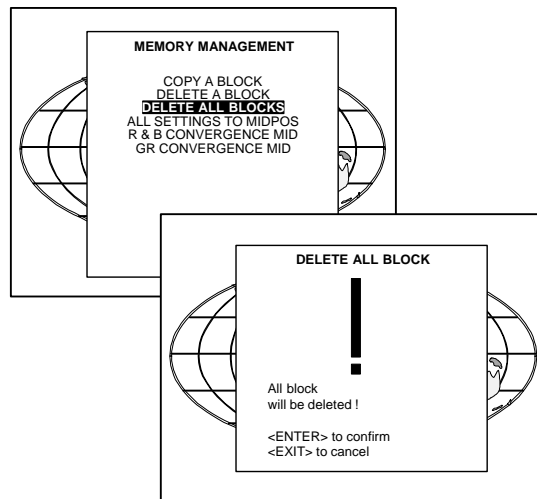

### All settings to midposition

Item is password protected.  
 Highlight '*All settings to midposition*' with the control disk and press **ENTER** to set all settings to their midposition.  
 A confirmation menu will be displayed first.

**ENTER** displays a Confirmation screen.  
**EXIT** returns to the Service menu.

**ENTER** will set all settings to their midposition. **EXIT** will cancel the operation to set all settings to their midposition.

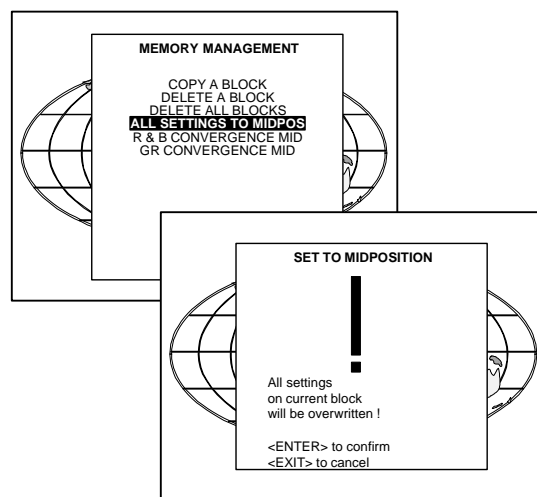

### Undo all settings to midpos

When "All settings to midpos" is selected, all settings are set to their midposition. To cancel this action, select 'Undo all settings to midpos' by pushing the control disk up or down and press **ENTER**. 'Undo all settings to Midposition' is displayed in the Memory management menu instead of 'All settings to midposition' when this latter is pressed.

An undo is possible as long as the projector is playing on the same source (= same adjustment block) even when some adjustments as geometry or convergence are already readjusted. When undo is pressed all settings are reset to the previous settings.

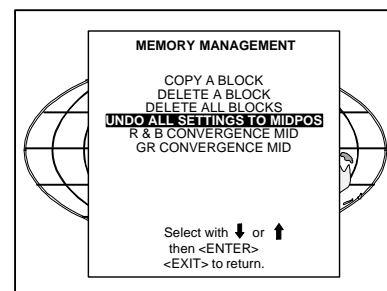

### R & B convergence mid

Item is password protected.

Highlight 'R & B convergence mid' with the control disk and press **ENTER** to set all convergence settings to their midposition. A confirmation screen will be displayed first.

**ENTER** sets the convergence settings to their midposition. **EXIT** cancels the procedure to set the convergence settings to their midposition.

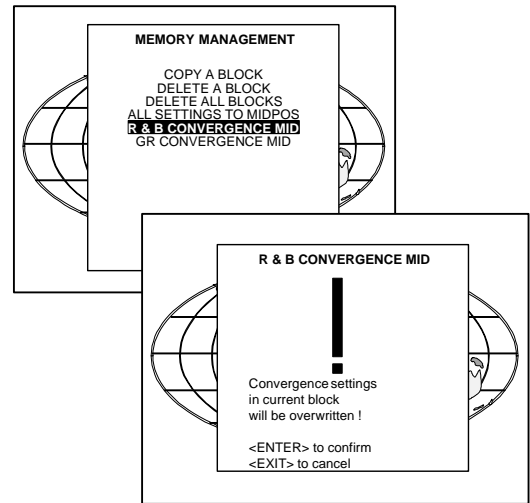

### Undo R & B convergence mid

When "R & B convergence mid" is selected, all convergence settings are set to their midposition. To cancel this action, select 'Undo R & B convergence mid' by pushing the control disk up or down and press **ENTER**. 'Undo R & B convergence mid' is displayed in the Memory management menu in stead off 'R & B convergence mid' when this latter is pressed.

An undo is possible as long as the projector is playing on the same source (= same adjustment block) even when some adjustments are already readjusted. When undo is pressed all settings are reset to the previous settings.

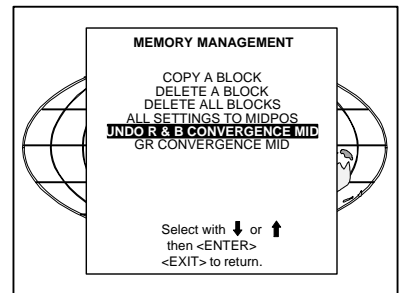

### Green convergence mid

Only available when the projector is equipped with green convergence adjustments.

Highlight 'Gr convergence mid' by pushing the control disk up or down and press **ENTER** to switch off the green convergence.

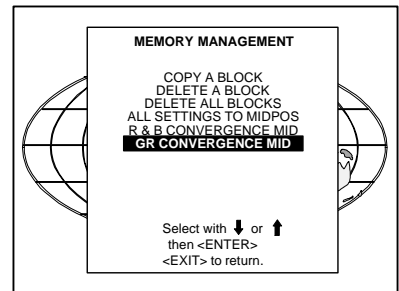

### Undo green convergence mid

Only available when the projector is equipped with green convergence adjustments.

The item 'Undo green convergence mid' will automatically be displayed when the green convergence is switched to midposition. Press **ENTER** to switch on the green convergence.

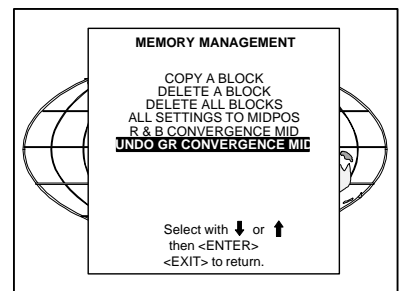

## Common Settings

Highlight '*Common settings*' by pushing the control disk up or down and press **ENTER** to display the common settings menu. Within the common settings menu, the following items can be set up or executed :

- G2 adjustment
- CRT run in cycle
- Projector warm up

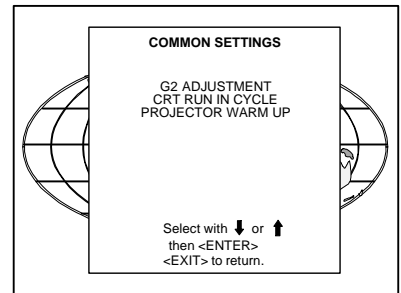
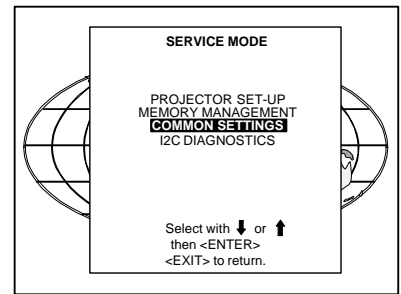

## G2 Adjustment

Item is password protected.

Highlight '*G2 adjust*' with the control disk and press **ENTER** to continue.

A safety notice will be displayed on the screen as it is necessary to open the top cover to adjust the G2.

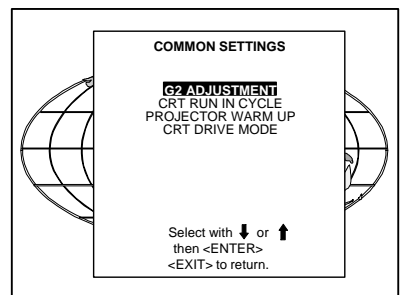

**ENTER** selects the G2 adjustment.  
**EXIT** returns to the Common settings menu.  
**ADJUST** returns to the Operational mode.

**'G2 adjustment should be performed by BARCO personnel, or BARCO authorized dealers'.**

If you are qualified, press **ENTER** to continue. If not qualified, press **EXIT** to return to the Common settings menu. Further description of the G2 adjustment is given in the Installation manual.

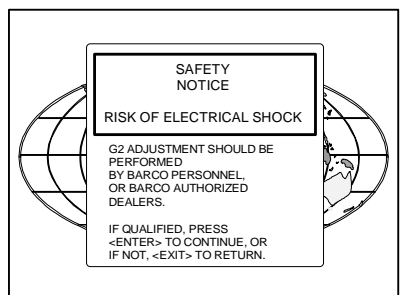

## CRT run in cycle

The CRT run in cycle option can only be activated when memory blocks on an internal # pattern are available. When one or more such blocks are available, a flashing white image (5sec on, 5 sec off) is generated and that for 5 min on the first internal block. In the next 5 min, a second internal block will be used to generate the flashing white image. The image will also be shifted in a vertical way to prevent a CRT burn in. To quit the CRT run in cycle option, press **EXIT**.

Highlight '*CRT run in cycle*' with the control disk and press **ENTER** to start.

**ENTER** selects the CRT run in cycle option.  
**EXIT** returns to the Path Selection main menu.

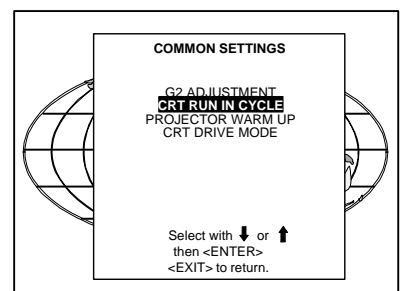

## Service Mode

If a memory block adjusted on an internal # pattern is available, the CRT run in cycle will start when pressing ENTER. If no such a block is available, the projector cannot run the CRT run in option and leaves the adjustment mode.

If you still want to run CRT run in cycle, create first a memory block on an internal # pattern and restart the CRT run in option.

**ENTER** starts the 'CRT run in' when an internal generated # pattern is available.

**EXIT** returns to the Path Selection main menu.

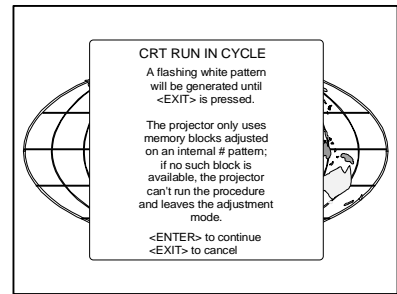

## Projector warm up

Highlight 'Projector warm up' by pushing the control disk up or down and press **ENTER** to select the projector warm up menu.

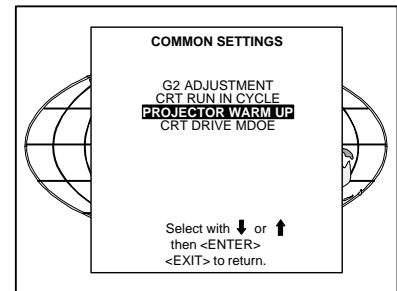

The ON/OFF option can be toggled with the **ENTER** key.

When in the ON position (and the CRT run in cycle is OFF), the projector can start up with a warm up periode of 20 minutes. During the start up a warm up menu will be displayed. This menu offers the possibility to skip the warm up periode anyway by pressing the **EXIT** key and offers the possibility to adjust the horizontal and vertical amplitude of this white image with the control disk. During this warm up period, a full white image is shifted on the CRT faceplate to avoid a burn in.

Every 30 seconds a text box will be displayed on another place on the screen with the remaining time to go.

When **EXIT** is pressed during this warm up periode, the warm up menu will be redisplayed with the remaining time indication. Press another time **EXIT** to interrupt the warm up cycle.

When the warm up option is OFF, when switching on the projector, it starts immediately with the projection of the selected source.

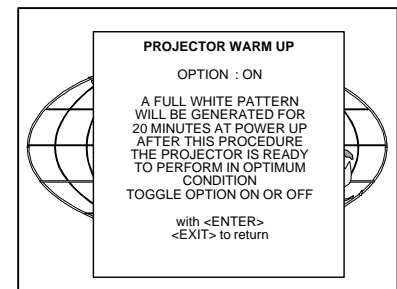

## CRT Drive Mode

The projector CRT's can be driven with the normal current (normal mode), a lower current (economic mode) or with a higher current (boost mode).

To change the drive mode, highlight 'CRT drive mode' by pushing the control stick forward or backward and press ENTER to display the CRT drive mode menu.

To change the boost mode, push the control disk up or down to select a display mode and press ENTER to select.

The following modes are available :

- Normal
- Economic : Lower drive current to the CRT's, the lifetime of the CRT's will enlarge but the light output will reduce.
- Tempory boost : Higher drive current to the CRT's, the lifetime of the CRT's will shorten but the light output will be higher. This situation is tempory, when restarting the projector, the drive mode is automatically set to normal.
- Permanent boost : Higher drive current to the CRT's, the lifetime of the CRT's will shorten but the light output will be higher. This setting will be saved in the EEPROM. When restarting the projector, it will start up in boost mode.

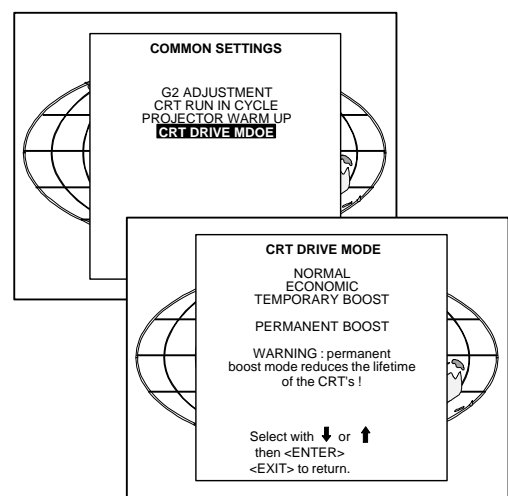

A warning, permanent BOOST mode in use, will be displayed to inform the user.  
 When text is on, this warning will be repeated every time a new source is selected.

**WARNING**  
 PERMANENT  
 BOOST MODE  
 IN USE !

### I2C Diagnostics

Highlights 'I2C Diagnostics' by pushing the control disk up or down and press **ENTER**.

The I2C diagnostics menu gives an overview of the I2C failures inside the projector.

To scroll through the failure list, push the control disk up or down. The I2C address, IC number and module name will be given in I2C diagnostic menu.

When no errors are detected, the following message will appear on the screen :

"No errors on i2c-bus detected".

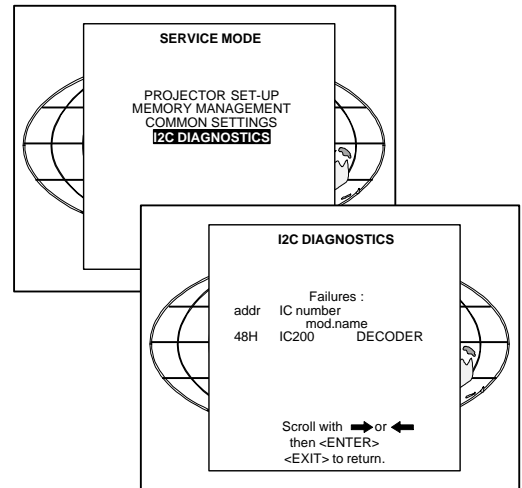



# 8

## MESSAGES, WARNINGS AND FAILURES

<p><b>INPUT 01</b> Fh= 15.6 kHz Fv= 050 Hz</p>	<p>When selecting a new source, information about this source will be displayed on the screen. Source number, horizontal and vertical frequencies of the displayed source.</p>	<p><b>WARNING :</b>  <b>invalid code entry</b></p>	<p>Message when the entered password is wrong.</p>
<p><b>SOURCE 01</b></p>	<p>Announcement of the selected source.</p>	<p><b>WARNING :</b>  <b>end of adjustment range</b></p>	<p>End of adjustment range.</p>
<p><b>enter password</b> x x x x</p>	<p>Message to enter your password. Password contains 4 digits.</p>	<p><b>WARNING :</b>  <b>input no longer available</b></p>	<p>Message will be displayed when the input source is no longer available. The following message then appears: <i>'check input signal or select new source'</i>.</p>
<p><b>text on</b></p>	<p>These messages will be displayed on the screen when pushing the TEXT key.</p>	<p><b>WARNING :</b>  <b>input selector not available</b></p>	<p>It warns you to check the power connection or the power status of the RCVDS.</p>
<p><b>text off</b></p>	<p>Text ON : the <i>'bar scale indication'</i> will be enabled during the change of an analog control in the <i>'operational mode'</i> + all warnings and failures will be displayed.</p>	<p><b>WARNING :</b>  <b>invalid frequency input</b></p>	<p>Next message will appear immediately on the screen : <i>'go to stand-by'</i>.</p>
<p><b>PROJECTOR ADDRESS :</b> <b>003</b></p>	<p>Text OFF : the <i>'bar scale indication'</i> will be disabled during the change of an analog control in the <i>'operational mode'</i> + all warnings and failures will not be displayed.</p>	<p><b>WARNING :</b>  <b>table is deleted</b></p>	<p>The entered frequency or applied frequency of the source is out of the projector's range.</p>
<p><b>WARNING :</b>  <b>input not available</b></p>	<p>Indication of the projector address when activating the <i>'ADDRESS'</i> button on the RCU with a pencil or other small object.</p>	<p><b>FAILURE</b>  <b>I2C error addr. : 7FH3</b></p>	<p>Message to inform that selected table is deleted. This message will be followed by <i>'confirm message'</i>, on which the user has to answer.</p>
<p><b>WARNING :</b>  <b>source not available</b></p>	<p>When using the projector with the RCVDS, this warning will be displayed when selecting an input slot of an RCVDS where the input board is missing.</p>	<p><b>FAILURE</b>  <b>short circuit on I2C bus</b></p>	<p>Hardware failure. Call a qualified service technician for repair.</p>
<p><b>WARNING :</b>  <b>invalid key entry</b></p>	<p>The input is a valid input but the source is not connected to the input terminals or the input source is switched off.</p>		<p>Hardware failure. Call a qualified service technician for repair.</p>
	<p>When a wrong key is pressed on the RCU.</p>		

**FAILURE  
RCVDS com-  
munication  
error**

Serial communication error between the RCVDS and the projector.

**FAILURE  
IRIS commu-  
nication  
error**

Communication error between IRIS 800 and the projector. Call a qualified service technician.

**WAIT  
starting  
up  
IRIS**

Message during the start up of the IRIS. Message will disappear when the IRIS is ready to accept commands.

**FAN FAILED  
Projector  
will  
switch off**

Message when one of the fans are not working anymore. Projector switches to stand-by



## MAGIK Interface

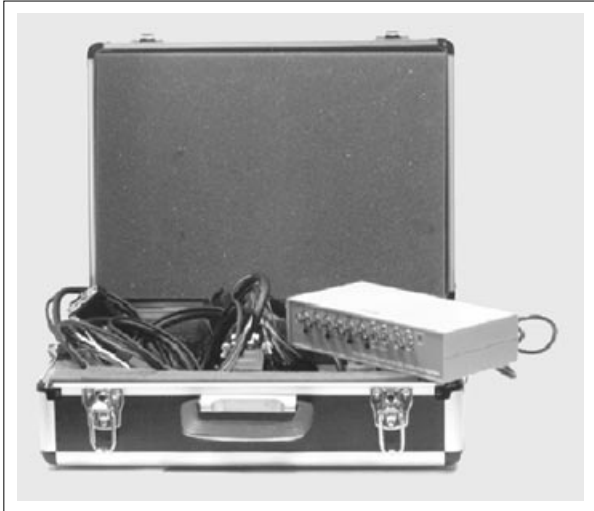

### Multifunctional Analog Graphics Interface Kit.

BARCO's MAGIK interface allows the user to connect a presentation device such as a projector or a professional monitor to any computer with analog video signal with or without maintaining the connection with its own display. The MAGIK interface buffers and amplifies any RGB analog signal with TTL or analog sync without signal loss or image degradation.

The MAGIK can be delivered together with connection cables for PC, MAC, SUN or workstation in a nice handbag case.

Order numbers MAGIK with cables and case :

R9828120 (230V)

R9828129 (120V)

Order number MAGIK only :

R9828121 (230V)

R9828128 (120V)

## Adapter and communication cables

BARCO provides several cables to connect peripheral equipment to the projector.

### a. D9-D9 communication cable

- To connect an IBM PC (or compatible) to the projector.
- To connect a RCVDS05 to the projector.
- To connect a IR receiver to the RCVDS05 to the projector.
- To be used as extension cable for all other adapter cables.

Available length :5 m (16ft), order number R982770; 15 m(50ft), order number R9827560; and 30 m (100ft), order number R9827570

### b. Din Mini8-D9 adapter cable.

- To connect a Macintosh computer to the projector.
- Available length : 1 m (3,2 ft), order number R9827640.

### c. D25-D9 adapter cable

- To connect a workstation to the projector.
- Available length : 1 m (3,2 ft), order number R9827630

### d. 5 BNC to 5 BNC cable

- To connect an analog source to the BNC input of the projector
- Available length :
- |         |                       |
|---------|-----------------------|
| 60 cm,  | order number R9828260 |
| 150 cm, | order number R9828261 |
| 5 m,    | order number R9828262 |
| 15 m,   | order number R9828263 |

## Orbiting Kit

Static pictures are very often shown on large screen projectors, especially in process control and presentation applications. Due to the fact that the same picture information is shown for a long period in the same place, picture tubes can be damaged by 'local burn-in'. To reduce this problem, a special Orbiting circuit is available which moves the picture very slowly around a predefined screen area. The cycle time is very long to make the movement of the projected image imperceptible.

The use of the orbiting kit is described in appendix A in the installation manual.

Order number : R9827780

## Line Doubler Kit

BARCO's line doubler kit consists of a video decoder with a three-line adaptive Comb filter, an enhancement circuit and the line doubler itself.

- The three-line adaptive Comb filter improves color transitions and reduces noise in the video signal.
- The enhancement circuit integrated in the decoder provides sharper images with clearer outlines.
- The line doubler circuit reduces visible line structure by doubling the number of lines of the video image.

These three circuits work in unison to produce a smoother yet sharper image which is significantly more appealing when watching video images.

Order number : R9828161

## Ceiling mount CM50

This suspension system enables to mount any projector from the BARCO 700 series to the ceiling without using any mechanical interface, and to adapt the projector perfectly to the local mounting requirements.

Order number CM50 with pulley : R9827990

Order number CM50 without pulley : R9827991.

## Soft edge matching kit

Multi-screens are popular for many applications. In these installations, the goal is to obtain a contiguous matched image, forming one homogenous view. The soft edge matching feature provides a solution to the annoying side effects when adjusting two or more projected images next to each other. To improve this junction, both images must be overlapping within a certain percentage of the total screen width. During the overlapping period, both video signals are modulated by appropriate waveforms so that the resulting light output equals the rest of the image.

## Contrast modulation kit

The contrast modulation kit is designed to improve overall light output uniformity and to overcome the inherent color shift errors, normally associated with CRT projection. The laws of physics applied to projection optics dictate that the center of the projected image will be brighter than the corners, this phenomenon is normally referred to as 'corner fall off'. Due to the normal off-axis projection of the red and blue images, CRT projection displays a phenomenon referred to as 'color shift', whereby one side of the image is reddish and the other blueish. By modulating the amplitude of the video signal with appropriate waveforms we are able to overcome both problems.

The use of this contrast modulation kit is described in appendix C.

Order number : R9827800

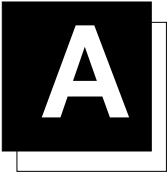

# ADJUSTMENT BLOCKS AND SOURCE NUMBERS 90 - 99

## Adjustment Blocks (memory blocks)

As the projector is digitally controlled, all geometry and convergence adjustments are stored in the projector's memory as numeric values. These numeric values are used to control digital potentiometers which in turn, control the projector. Each source connected to the projector has a unique set of adjustment data which is automatically downloaded into the projector's digital potentiometers once the source has been selected. This set of adjustment data is referred to as an "adjustment block".

An adjustment table is automatically created for a source when the source is first connected to the projector and the Adjustment mode is entered. If other sources have already been connected to the projector and geometry and convergence adjustments have been performed on these sources, the projector will use Linear Digital Interpolation to create a new block for the new source. This block will provide an initial set of adjustments for the new source that have been calculated by the projector from "previous experience".

The projector's memory has the capacity to store 32 adjustment blocks. The adjustment block consists of two parts, the block header and the data representing the values for all adjustments (eg. Convergence and Geometry) in the projector for the source the block corresponds to. The block header contains the basic characteristics of the source and the projector configuration used to display the source.

Block Header	example of block header
Block Number	01
Source Number	01
Horizontal Frequency	15.6 kHz
Vertical Frequency	50 Hz
Input Type	video
Scan Switch Configuration	Front/Ceiling

The data representing the various adjustments for the source follows the block header.

## Source numbers 90 - 99

Source numbers 90 - 99 do not correspond to physical inputs to the projector or RCVDS. They are used to assign an additional adjustment block to a source. This additional adjustment block may contain different geometry and convergence settings, sync fast/slow positions and enhanced blue on/off settings. The relationship between source numbers 0 - 9 and 90 - 99 (projector with RCVDS) or 1 - 5 and 91 - 95 (stand-alone projector) is shown in the diagram below.

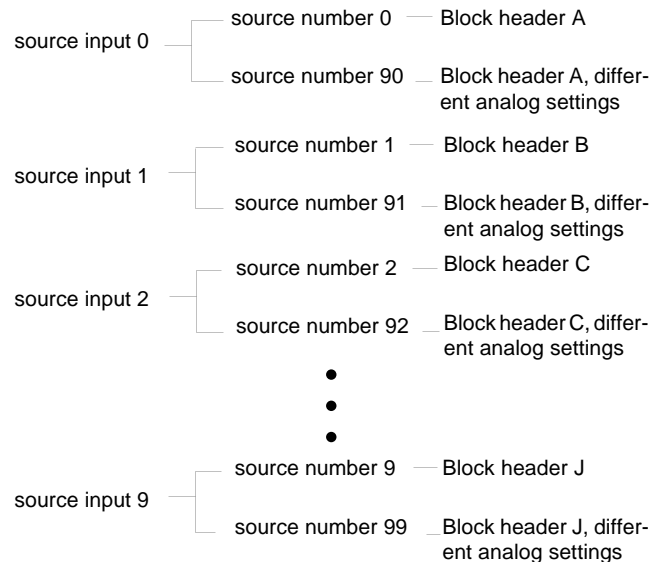

The alternate adjustment block for sources 0 - 9 (projector with RCVDS) or 1 - 5 (stand-alone projector) is activated by selecting the corresponding source number 0 - 9 (projector with RCVDS) or 1 - 5 (stand-alone projector). Once this source number is selected, the alternate block of adjustment data is in use and may be modified via the adjust mode of the projector. The alternate adjustment block is automatically stored.

Follow the steps below to create a second adjustment block for a source between 0 and 9.

1. Select the source between 0 and 9 that the second adjustment block is to be created for.

2. Select the corresponding source number between 90 and 99. The adjustment block for the source number between 0 and 9 is copied to the corresponding source number between 90 and 99.

3. Enter the adjust mode and make any desired changes (geometry, convergence, sync fast/slow, enhanced blue on/off) to the second adjustment block.

4. Exit the adjust mode.

Note : the above also applies to source number 1 - 5 and 91 - 95 of a stand alone projector (no RCVDS)



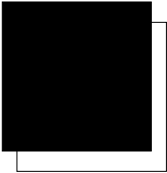

# INSERT CARD

	<b>RCU</b>	<b>RCU</b>
	<b>INPUT SOURCES</b>	<b>INPUT SOURCES</b>
	<b>PROJECTOR</b>	<b>PROJECTOR</b>
	1	1
	2	2
	3	3
	4	4
	5	5
	6	6
	7	7
	<b>INPUT SOURCES</b>	<b>INPUT SOURCES</b>
	<b>RCVDS</b>	<b>RCVDS</b>
	1	1
2	2	
3	3	
5	5	
6	6	
7	7	
8	8	
9	9	
10	10	

✂